



User Manual

X3U&X4U&X5U&X6U

Revision History

Document VER	Firmware VER	Explanation	Time
V1.0	X3U: 1.1.20 X4U/X5U/X6U: 1.0.0	Initial issue	20190829

Directory

Directory	3
1 Picture	8
2 Table	12
3 Safety Instruction	13
4 Overview	14
4.1 Overview.....	14
4.2 Hardware Description.....	14
4.3 Packing Contents.....	15
5 Desktop Installation	16
5.1 PoE and the use of external power adapters.....	16
5.2 Desktop and wall mounted method.....	17
6 Appendix Table	19
6.1 Appendix I - Icon.....	19
6.2 Appendix II - Keyboard character query table.....	22
Appendix III –LED Definition.....	24
7 Introduction to the User	25
7.1.1 X3U.....	25
7.1.2 X4U/X5U.....	27
7.1.3 Instruction of Keypad of X6U.....	29
7.2 Using Handset / Hands-free Speaker / Headphone.....	30
7.3 Idle Screen.....	31
7.4 Phone Status.....	32
7.5 Web Management.....	33
7.6 Network Configurations.....	33
7.7 SIP Configurations.....	34
8 Basic Function	36
8.1 Making Phone Calls.....	36
8.2 Answering Calls.....	37
8.2.1 Talking.....	38
8.2.2 Make / Receive Second Call.....	38
8.3 End of the Call.....	39
8.4 Redial.....	39
8.5 Dial-up Query.....	40
8.6 Auto-Answering.....	40

8.7 Callback.....	42
8.8 Mute.....	42
8.8.1 Mute the Call.....	43
8.8.2 Ringing Mute.....	43
8.9 Call Hold/Resume.....	43
8.10 DND.....	44
8.11 Call Forward.....	46
8.12 Call Transfer.....	47
8.12.1 Blind transfer.....	47
8.12.2 Semi-Attended transfer.....	48
8.12.3 Attended transfer.....	48
8.13 Call Waiting.....	49
8.14 Conference.....	50
8.14.1 Local Conference.....	50
8.14.2 Network Conference.....	51
8.15 Call Park.....	51
8.16 Pick Up.....	52
8.17 Anonymous Call.....	53
8.17.1 Anonymous Call.....	53
8.17.2 Ban Anonymous Call.....	54
8.18 Hotline.....	55
8.19 Emergency Call.....	56
9 Advance Function.....	58
9.1 BLF (Busy Lamp Field).....	58
9.1.1 Configure the BLF Functionality.....	58
9.1.2 Use the BLF Function.....	59
9.2 BLF List.....	60
9.3 Record.....	61
9.3.1 Local Record (USB flash disk).....	61
9.3.2 Server Record.....	61
9.3.3 SIP INFO Record.....	62
9.4 Agent.....	62
9.5 Intercom.....	64
9.6 MCAST.....	64
9.7 SCA (Shared Call Appearance).....	65
9.8 Message.....	68
9.8.1 SMS.....	68
9.8.2 MWI (Message Waiting Indicator).....	69

9.9 SIP Hotspot.....	70
10 Phone Settings.....	73
10.1 Basic Settings.....	73
10.1.1 Language.....	73
10.1.2 Time & Date.....	73
10.1.3 Screen.....	75
10.1.3.1 Brightness and backlight.....	75
10.1.3.2 Screen Saver.....	76
10.1.4 Ring.....	76
10.1.5 Voice Volume.....	76
10.1.6 Greeting Words.....	77
10.1.7 Reboot.....	77
10.2 Phone Book.....	77
10.2.1 Local Contact.....	77
10.2.1.1 Add / Edit / Delete Contact.....	78
10.2.1.2 Add / Edit / Delete Group.....	78
10.2.1.3 Browse and Add / Remove Contacts in Group.....	79
10.2.2 Blacklist.....	79
10.2.3 Cloud Phone Book.....	80
10.2.3.1 Configure Cloud Phone book.....	80
10.2.3.2 Downloading Cloud Phone book.....	81
10.3 Call Log.....	81
10.4 Function Key.....	82
10.5 Wi-Fi.....	84
10.6 Headset.....	84
10.6.1 Wired Headset.....	84
10.6.2 EHS Headset.....	85
10.6.3 Bluetooth Headset.....	85
10.7 Advanced.....	86
10.7.1 Line Configurations.....	86
10.7.2 Network Settings.....	87
10.7.2.1 Network Settings.....	87
10.7.2.2 QoS & VLAN.....	89
10.7.2.3 VPN.....	89
10.7.2.4 Web Server Type.....	90
10.7.3 Set The Secret Key.....	91
10.7.4 Maintenance.....	92
10.7.5 Firmware Upgrade.....	95

10.7.6 Factory Reset.....	97
11 Web Configurations.....	98
11.1 Web Page Authentication.....	98
11.2 System >> Information.....	98
11.3 System >> Account.....	98
11.4 System >> Configurations.....	98
11.5 System >> Upgrade.....	99
11.6 System >> Auto Provision.....	99
11.7 System >> Tools.....	99
11.8 System >> Reboot Phone.....	99
12 Network >> Basic.....	100
12.1 Network >> Service Port.....	100
12.2 Network >> VPN.....	100
12.3 Network >> Advanced.....	101
12.4 Line >> SIP.....	101
12.5 Line >> SIP Hotspot.....	106
12.6 Line >> Dial Plan.....	106
12.7 Line >> Action Plan.....	108
12.8 Line >> Basic Settings.....	109
12.9 Line >> RTCP-XR.....	109
12.10 Phone settings >> Features.....	110
12.11 Phone settings >> Media Settings.....	113
12.12 Phone settings >> MCAST.....	115
12.13 Phone settings >> Action.....	115
12.14 Phone settings >> Time/Date.....	115
12.15 Phone settings >> Tone.....	116
12.16 Phone settings >> Advanced.....	117
12.17 Phonebook >> Contact.....	117
12.18 Phonebook >> Cloud phonebook.....	118
12.19 Phonebook >> Call List.....	119
12.20 Phonebook >> Web Dial.....	119
12.21 Phonebook >> Advanced.....	119
12.22 Call Log.....	119
12.23 Function Key >> Function Key.....	120
12.24 Function Key >> Side Key.....	120
12.25 Function Key >> Softkey.....	121
12.26 Function Key >> Advanced.....	122
12.27 Application >> Manage Recording.....	122

12.28 Security >> Web Filter.....	122
12.29 Security >> Trust Certificates.....	123
12.30 Security >> Device Certificates.....	123
12.31 Security >> Firewall.....	124
12.32 Device Log >> Device Log.....	125
13 Trouble Shooting.....	126
13.1 Get Device System Information.....	126
13.2 Reboot Device.....	126
13.3 Reset Device to Factory Default.....	126
13.4 Screenshot.....	126
13.5 Network Packets Capture.....	127
13.6 Get Log Information.....	128
13.7 Common Trouble Cases.....	128

1 Picture

Picture 1 - Device installation.....	17
Picture 2 - Wall-mounted installation.....	17
Picture 3 - Connecting to the Device.....	18
Picture 4 - Instruction of Keypad of X3U.....	25
Picture 5 - Instruction of Keypad of X4U&X5U.....	27
Picture 6 - Instruction of Keypad of X6U.....	29
Picture 7 - Screen layout/default home screen.....	31
Picture 8 - Scroll icon.....	32
Picture 9 - The Phone status.....	32
Picture 10 - WEB phone status.....	33
Picture 11 - Landing page.....	33
Picture 12 - Phone line SIP address and account information.....	35
Picture 13 - Web SIP registration.....	35
Picture 14 - Default line.....	36
Picture 15 - Enable voice channel dialing.....	36
Picture 16 - Open the voice channel and dial the number.....	37
Picture 17 - Call number.....	37
Picture 18 - Answering calls.....	37
Picture 19 - Talking interface.....	38
Picture 20 - The second call interface.....	38
Picture 21 - Two way calling.....	39
Picture 22 - Redial set.....	40
Picture 23 - Line 1 enables auto-answering.....	41
Picture 24 - The line has enabled auto-answering.....	41
Picture 25 - Web page to start auto-answering.....	41
Picture 26 - Set the callback key on the phone.....	42
Picture 27 - Set the callback key on the web page.....	42
Picture 28 - Mute the call.....	43
Picture 29 - Ringing mute.....	43
Picture 30 - Call hold interface.....	44
Picture 31 - Enable DND.....	44
Picture 32 - DND setting interface.....	44
Picture 33 - DND timer.....	45
Picture 34 - DND Settings.....	45
Picture 35 - Line DND.....	45
Picture 36 - Select the line to set up call forwarding.....	46

Picture 37	- Select call forward type.....	46
Picture 38	- Enable call forwarding and configure the call forwarding number.....	47
Picture 39	- Set call forward.....	47
Picture 40	- Transfer interface.....	48
Picture 41	- Semi-Attended transfer.....	48
Picture 42	- Attended transfer.....	48
Picture 43	- Call waiting setting.....	49
Picture 44	- Web call waiting setting.....	49
Picture 45	- Web call waiting tone setting.....	50
Picture 46	- Local conference setting.....	50
Picture 47	- Local conference (1).....	50
Picture 48	- Local conference (2).....	51
Picture 49	- Network conference.....	51
Picture 50	- Phone set call park.....	52
Picture 51	- WEB set call park.....	52
Picture 52	- Phone pick up setting.....	53
Picture 53	- WEB pick up setting.....	53
Picture 54	- Enable anonymous call.....	54
Picture 55	- Enable Anonymous web page call.....	54
Picture 56	- Anonymous call log.....	54
Picture 57	- Anonymous calls are not allowed on the phone.....	55
Picture 58	- Page Settings blocking anonymous call.....	55
Picture 59	- Phone hotline setting interface.....	55
Picture 60	- Hotline set up on webpage.....	56
Picture 61	- Set up an emergency call number.....	56
Picture 62	- Dial the emergency number.....	57
Picture 63	- Web page configuration BLF function key.....	58
Picture 64	- Phone configuration BLF function key.....	58
Picture 65	- Configure the BLF List functionality.....	60
Picture 66	- BLF List number display.....	60
Picture 67	- Local Record.....	61
Picture 66	- Web server recording.....	62
Picture 69	- Web SIP info recording.....	62
Picture 70	- Configure the agent account in normal mode.....	63
Picture 71	- Configure the proxy account-hotel Guest mode.....	63
Picture 72	- Agent logon page.....	64
Picture 73	- Web Intercom configure.....	64
Picture 74	- Multicast Settings Page.....	65

Picture 75	- Register BroadSoft account.....	66
Picture 76	- Set BroadSoft server.....	66
Picture 75	- Enable SCA.....	67
Picture 76	- Set Private Hold Function Key.....	67
Picture 79	- SMS icon.....	69
Picture 80	- New Voice Message Notification.....	69
Picture 81	- Voice message interface.....	70
Picture 82	- Configure voicemail number.....	70
Picture 83	- Register SIP account.....	71
Picture 84	- SIP hotspot server configuration.....	72
Picture 85	- SIP hotspot client configuration.....	72
Picture 86	- Phone language setting.....	73
Picture 87	- Language setting on Web page.....	73
Picture 88	- Set time & date on phone.....	74
Picture 89	- Set time & date on webpage.....	74
Picture 90	- Set screen parameters on phone.....	75
Picture 91	- Page screen Settings.....	76
Picture 92	- Phone screen saver.....	76
Picture 93	- Phone book screen.....	77
Picture 94	- Local Phone book	78
Picture 95	- Add New Contact.....	78
Picture 96	- Group List.....	79
Picture 97	- Browsing Contacts in a Group.....	79
Picture 98	- Add Contacts in a Group.....	79
Picture 99	- Add Blacklist.....	80
Picture 100	- Web Blacklist.....	80
Picture 101	- Cloud phone book list.....	81
Picture 102	- Downloading Cloud Phone book.....	81
Picture 103	- Browsing Contacts in Cloud Phone book.....	81
Picture 104	- Call Log.....	82
Picture 105	- Filter call record types.....	82
Picture 106	- DSS LCD key Page Configuration Screen.....	83
Picture 107	- DSS settings.....	83
Picture 108	- WIFI settings.....	84
Picture 109	- Headset function settings.....	85
Picture 110	- EHS Headset setting.....	85
Picture 111	- Bluetooth Settings Screen.....	86
Picture 112	- SIP address and account information.....	86

Picture 113	- Configure Advanced Line Options.....	87
Picture 114	- Network mode Settings.....	87
Picture 115	- DHCP network mode.....	87
Picture 116	- PPPoE network mode.....	88
Picture 117	- Static IP network mode.....	88
Picture 118	- IPv6 Static IP network mode.....	89
Picture 119	- The phone configures the web server type.....	91
Picture 120	- Keypad lock password.....	91
Picture 121	- Set keyboard lock password	91
Picture 122	- Phone keypad lock password input interface.....	92
Picture 123	- Web keyboard lock password Settings.....	92
Picture 124	- Page auto provision Settings.....	92
Picture 125	- Phone auto provision settings.....	93
Picture 126	- Web page firmware upgrade.....	95
Picture 127	- Firmware upgrade information display.....	95
Picture 128	- Firmware upgrade.....	97
Picture 129	- Service Port Settings.....	100
Picture 130	- Dial plan settings.....	106
Picture 131	- Custom setting of dial - up rules.....	107
Picture 132	- Dial rules table (1).....	108
Picture 133	- Dial rules table (2).....	108
Picture 134	- Tone settings on the web.....	117
Picture 135	- Web cloud phone book Settings.....	119
Picture 136	- Global Key Settings.....	122
Picture 137	- Web Filter settings.....	122
Picture 138	- Web Filter Table.....	123
Picture 139	- Certificate of settings.....	123
Picture 140	- Device certificate setting.....	124
Picture 141	- Network firewall Settings.....	124
Picture 142	- Firewall Input rule table.....	125
Picture 143	- Delete firewall rules.....	125
Picture 144	- Screenshot.....	127
Picture 145	- Web capture.....	127

2 Table

Table 1	- Hardware Datasheet.....	14
Table 2	- Hardware Interface Description.....	18
Table 3	- Keypad Icons.....	19
Table 4	- Status Prompt and Notification Icons.....	19
Table 5	- DSSKEY Icon.....	21
Table 6	- Look-up Table of Characters.....	22
Table 7	- DSS KEY LED State.....	24
Table 8	- Instruction of Keypad of X3U.....	25
Table 9	- Instruction of Keypad of X4U&X5U.....	27
Table 10	- Instruction of Keypad of X6U.....	29
Table 11	- Talking mode.....	38
Table 12	- BLF Function key subtype parameter list.....	58
Table 13	- Agency mode.....	63
Table 14	- Intercom configure.....	64
Table 15	- MCAST Parameters on Web.....	65
Table 16	- LED Status of SCA.....	68
Table 17	- SIP hotspot Parameters.....	71
Table 18	- Time Settings Parameters.....	74
Table 19	- QoS & VLAN.....	89
Table 20	- Auto Provision.....	93
Table 21	- Firmware upgrade.....	95
Table 22	- Service port.....	100
Table 23	- Line configuration on the web page.....	101
Table 24	- Phone 7 dialing methods.....	106
Table 25	- Dial - up rule configuration table.....	107
Table 26	- IP camera.....	109
Table 27	- Set the line global configuration on the web page.....	109
Table 28	- VQ RTCP-XR Settings.....	109
Table 29	- General function Settings.....	110
Table 30	- Voice settings.....	114
Table 31	- Multicast parameters.....	115
Table 32	- Time&Date settings.....	115
Table 33	- Function Key configuration.....	120
Table 34	- Softkey configuration.....	121
Table 35	- Network Firewall.....	124
Table 36	- Trouble Cases.....	128

3 Safety Instruction

Please read the following safety notices before installing or using this unit. They are crucial for the safe and reliable operation of the device.

- Please use the external power supply that is included in the package. Other power supply may cause damage to the phone and affect the behavior or induce noise.
- Before using the external power supply in the package, please check the home power voltage. Inaccurate power voltage may cause fire and damage.
- Please do not damage the power cord. If power cord or plug is impaired, do not use it because it may cause fire or electric shock.
- Do not drop, knock or shake the phone. Rough handling can break internal circuit boards.
- This phone is designed for indoor use. Do not install the device in places where there is direct sunlight. Also do not put the device on carpets or cushions. It may cause fire or breakdown.
- Avoid exposure the phone to high temperature or below 0°C or high humidity.
- Avoid wetting the unit with any liquid.
- Do not attempt to open it. Non-expert handling of the device could damage it. Consult your authorized dealer for help, or else it may cause fire, electric shock and breakdown.
- Do not use harsh chemicals, cleaning solvents, or strong detergents to clean it. Wipe it with a soft cloth that has been slightly dampened in a mild soap and water solution.
- When lightning, do not touch power plug, it may cause an electric shock.
- Do not install this phone in an ill-ventilated place. You are in a situation that could cause bodily injury. Before you work on any equipment, be aware of the hazards involved with electrical circuitry and be familiar with standard practices for preventing accidents.

4 Overview

4.1 Overview

XU series include high-end enterprise DSS intelligent display color screen phone, which greatly improve enterprise production efficiency with advanced design, high cost performance, paperless office tool. It is not only a desktop phone, but also an elegant article that puts in the sitting room or office.

XU series, Fanvil enterprise IP phones, which are the latest generation of IP phone developed on the basis of the X series, inheriting many excellent features of the previous X series traditional phone, such as high-definition voice, headphones and high-performance echo cancellation full duplex speaker, fast / gigabit Ethernet, QoS, encryption transmission, automatic configuration, new system, smooth operation, flat interface settings and many other advantages.

For enterprise users, XU series are the cost-effective office equipment, while realizing environmental protection, they also provide convenient operation. Users can flexibly configure and define the functions of two DSS keys, space saving and cost. It will be an ideal choice for enterprise users and family users who pursue the high quality and high efficiency.

In order to help some interested users better understand the details of the product, this user manual can be used as a reference guide for the use of XU series. This document may not be applicable to the latest version of the software. If you have any questions, you can use the help prompt interface of the device phone, or download and update your user manual from the official website.

4.2 Hardware Description

Hardware info of XU series Phone:

Table 1 - Hardware Datasheet

Hardware	X3U	X4U	X5U	X6U
Screen	Color-Screen	Color-Screen	Color-Screen	Color-Screen
Sub-Screen	No	Yes	Yes	Yes
Side key	Yes	Yes	Yes	Yes
USB	No	Yes	Yes	Yes
DSSKEY LED	Yes	Yes	Yes	Yes

4.3 Packing Contents

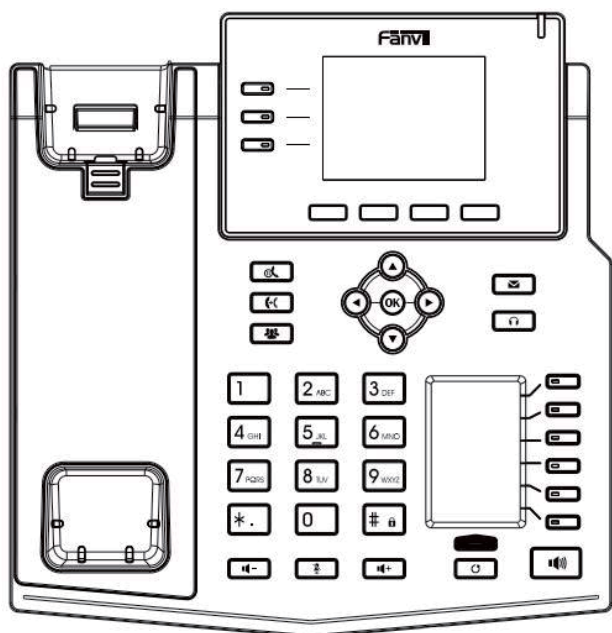

Phone

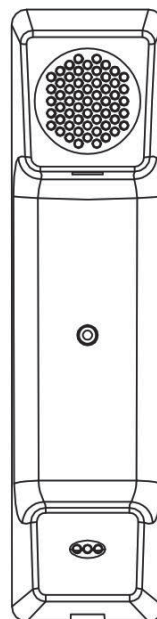

Handset

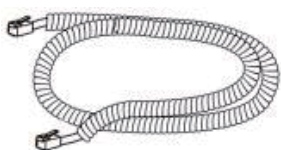

Receiver cable



Stand



Network cable



Power adapter (Optional)

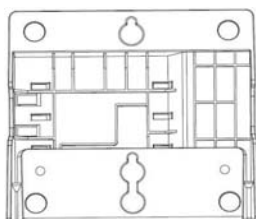

Hanging bracke (Need another purchase)

5 Desktop Installation

5.1 PoE and the use of external power adapters

The devices support two power supply modes from external power adapter or over Ethernet (PoE) complied switch.

PoE power supply saves the space and cost of providing the device additional power outlet. With a PoE switch, the device can be powered through a single Ethernet cable which is also used for data transmission. By attaching UPS system to PoE switch, the device can keep working at power outage just like traditional PSTN telephone which is powered by the telephone line.

For users who do not have PoE equipment, the traditional power adaptor should be used. If the device is connected to a PoE switch and power adapter at the same time, the power adapter will be used in priority and will switch to PoE power supply once it fails.

Please use the power adapter supplied by Fanvil and the PoE switch met the specifications to ensure the device to work properly.

5.2 Desktop and wall mounted method

The device supports two installation modes, desktop and wall mounted. If the phone is on the desktop, please follow the instructions in the picture below to install the phone.

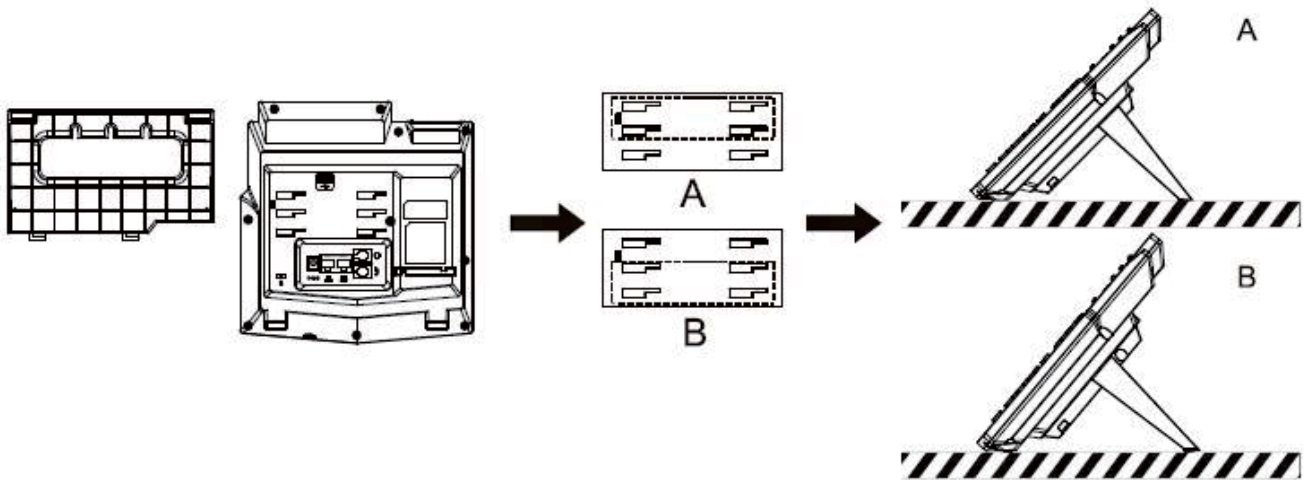

Picture 1 - Device installation

If the phone is mounted on the wall, please follow the instructions below to install it.

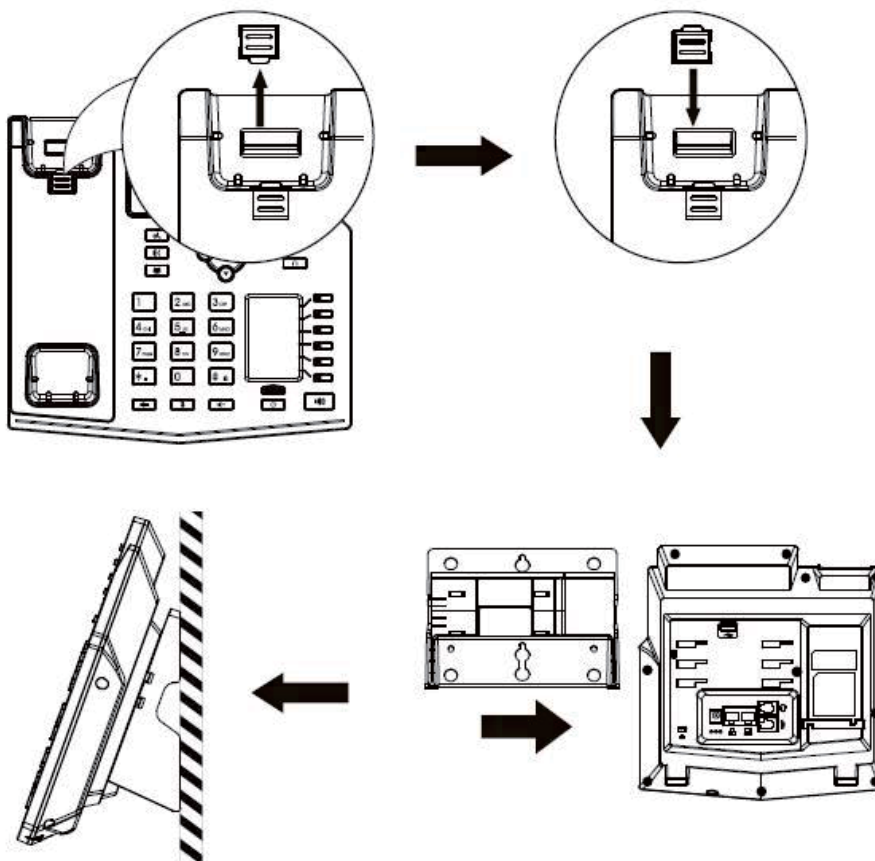

Picture 2 - Wall-mounted installation

Connect the power adapter, network, PC, phone and earphone to the appropriate port as shown in the picture below.

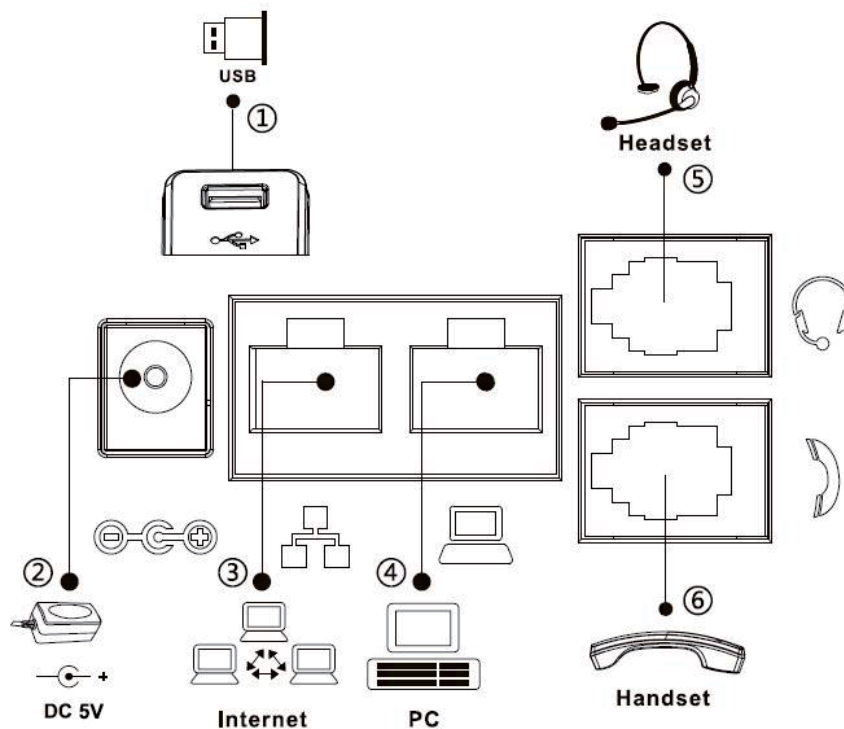

Picture 3 - Connecting to the Device

Table 2 - Hardware Interface Description

Index	Interface	Description	Note
①	USB Port	Connecting USB Disk and USB WIFI Adapter	X3U does not support this port
②	Power Port	Connecting Power Adapter	
③	Network Port	Connecting to LAN or Internet	
④	PC Port	Network Interface for Connecting Computer	
⑤	Headset Port	Connecting Headset	
⑥	Receiver Port	Connecting Microphone Receiver	

6 Appendix Table

6.1 Appendix I - Icon

Table 3 - Keypad Icons

Icon	Description	Model
	Redial	X3U/X4U/X5U/X6U
	Phone Book	X3U/X6U
	Hands-free (HF) speaker	X3U/X4U/X5U/X6U
	Mute Microphone (During Call)	X3U/X4U/X5U/X6U
	Volume down	X3U/X4U/X5U/X6U
	Volume up	X3U/X4U/X5U/X6U
	Hold	X3U/X4U/X5U/X6U
	Headset	X3U/X4U/X5U/X6U
	MWI	X3U/X4U/X5U/X6U
	Conference	X3U/X4U/X5U/X6U
	Transfer	X3U/X4U/X5U/X6U
	Call log	X6U
	Next Page Key	X4U/X5U/X6U

Table 4 - Status Prompt and Notification Icons

Screen Icon	Description
	Call out
	Call in
	Call Hold
	Network Disconnected
	Open VLAN
	Open VPN
	Keypad Locked

	Call forward calls
	Outgoing calls
	Incoming calls
	Missed calls
	SMS
	New voice message waiting
	Do-Not-Disturb inactivated on Phone
	Call forward activated
	Auto-answering activated
	Hands-free (HF) Mode
	Headphone (HP) Mode
	Handset (HS) Mode
	Mute Microphone
	The Voice quality of calling
	The Voice encryption of calling
	Speech High Definition
	Record
	SIP Hotspot
	Bluetooth































	Wi-Fi
	USB Insert
	USB overload

Table 5 - DSSKEY Icon

DSSKEY Icon	Side key Icon	Description
		BLF/New call
		BLF/XFER
		BLF/AXFER
		BLF/Conference
		BLF/DTMF
		Presence
		Voice Message
		Speed Dial
		Intercom
		Call Park
		Call Forward
		Keyevent
		URI
		BLF List

		MCAST Paging
	I	None for Memory Key
		None for DSSKEY
		Line Key
		DTMF

Note: The above table side key icons are applicable models: X3U/X4U/X5U/X6U.

6.2 Appendix II - Keyboard character query table

Table 6 - Look-up Table of Characters

Mode Icon	Text Mode	Key Button	Characters Of Each Press
	Numeric	1	1
		2	2
		3	3
		4	4
		5	5
		6	6
		7	7
		8	8
		9	9
		0	0
		*	*.+
#	#		
	Lower Case Alphabets	1	@:;()<>
		2	a b c
		3	d e f
		4	g h i
		5	j k l
		6	m n o
		7	p q r s
		8	t u v
		9	w x y z

		0	(space)
		*	.,*/+:-_ =
		#	# ^!&\$%
ABC	Upper Case Alphabets	1	@:;)(<>
		2	A B C
		3	D E F
		4	G H I
		5	J K L
		6	M N O
		7	P Q R S
		8	T U V
		9	W Z Y X
		0	(space)
		*	.,*/+:-_ =
		#	# ^!&\$%
		2aB	Mixed type input
2	2 a b c A B C		
3	3 d e f D E F		
4	4 g h I G H I		
5	5 j k I J K L		
6	6 m n o M N O		
7	7 p q r s P Q R S		
8	8 t u v T U V		
9	9 w z y x W Z Y X		
0	0		
*	.,*/+:-_ =		
#	# ^!&\$%		

Appendix III –LED Definition

Table 7 - DSS KEY LED State

Type	LED Light	State
Line Key	Off	Line inactive
	Green On	Line ready (Registered)
	Green Blinking	Ringing
	Red Blinking	Line is trying to register
	Red Blinking	Line error (Registration failure)
	Red On	Dialing/Line in use (Talking)
	Yellow Blinking	Call holding
BLF	Green On	Subscription number is idle.
	Red On	Subscription number is busy.
	Red On	Subscription number is dialing.
	Off	Subscription number is unavailable.
Presence	Green On	Subscription number is idle.
	Red On	Subscription number is busy.
	Red On	Subscription number is dialing.
	Off	Subscription number is unavailable.
DND	Red On	Enable DND
	Off	Disable DND
MWI	Green Blinking	New voice message waiting
	Off	No new voice message

7 Introduction to the User

7.1.1 X3U

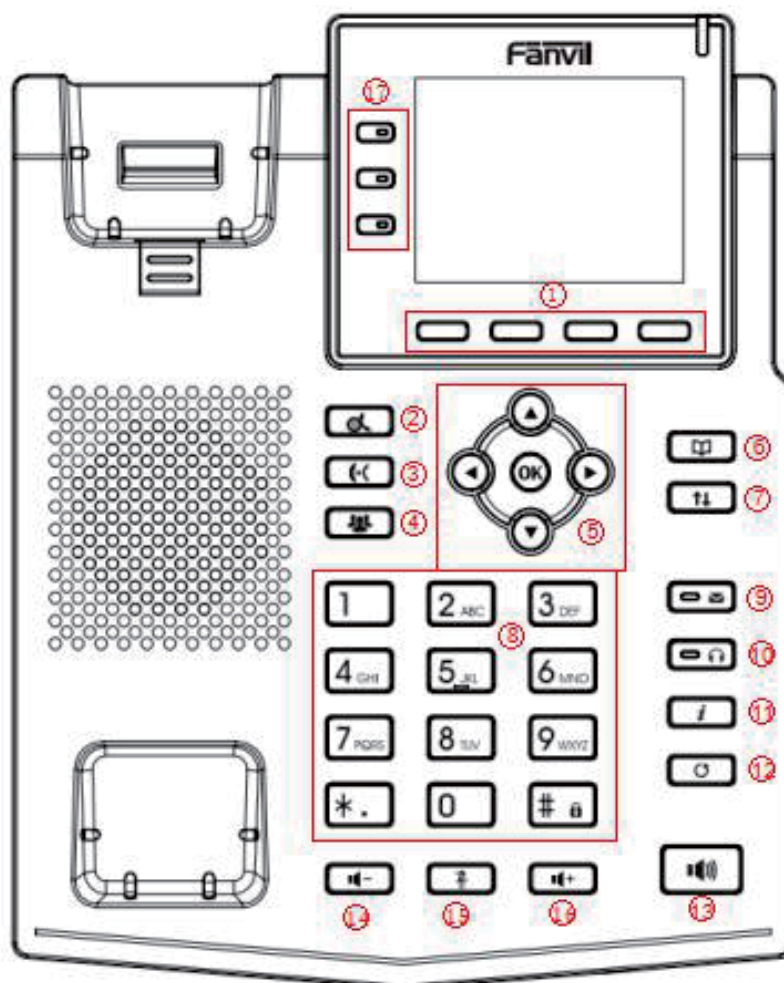

Picture 4 - Instruction of Keypad of X3U

Table 8 - Instruction of Keypad of X3U

Number	The keypad names	Instruction
①	Soft-menu Buttons	These four buttons provide different functions corresponding to the soft-menu displayed on the screen.
②	Hold Key	Press the "Hold" key during the call, the user can hold the call, and press it again to cancel the holding and restore the normal call state.
③	Transfer Key	Press the "Transfer" button, the user can transfer the current call to other numbers.
④	Conference	Press the "Conference" button, the user can initiate a three-party conference.

⑤	Navigate/OK Keys	<p>The user can press the up/down navigation key to change the line or move the cursor in the screen list. On some Settings and text editing pages, the user can press the left/right navigation key to change options or move the cursor in the screen list to the left/right.</p> <p>OK key: Default is equivalent to soft button confirmation; user can customize the function.</p>
⑥	voice mail	<p>Press the "voice mail" button, and the user enters the interface of SMS and voice mail list.</p>
⑦	Headset Key	<p>Users can press this key to open the headset</p>
⑧	Standard Telephone Keys	<p>The 12 standard telephone keys provide the same function as standard telephones, but further to the standard function, some keys also provide special function by long-pressing the key,</p> <p>Key  - Long-pressed to lock the phone.</p>
⑨	Contact Key	<p>Press the "Contact" key, the user can enter the address book interface and select the contact person to call.</p>
⑩	Call Log Key	<p>Press the "Call Log" button and the user can see the incoming/outgoing calls.</p>
⑪	Status key	<p>The user can press this key to view the status information of the device</p>
⑫	Redial	<p>Press the Redial key to redial the last number dialed</p>
⑬	Hands-free Key	<p>The user can press this key to open the audio channel of the speakerphone.</p>
⑭	Volume Down Key	<p>In the standby state, ring and ring configuration interface, press this button to reduce the ring volume; Press this button to lower the volume on the call or volume adjustment screen.</p>
⑮	Mute Key	<p>During a call, the user can press this key to mute the microphone.</p>
⑯	Volume Up Key	<p>In the standby state, ring and ring configuration interface, press this button to increase the ring volume; Press this button to increase the volume on the call or volume adjustment screen.</p>
⑰	Side Key	<p>Long press the side key to enter the settings interface and set the required functions.</p>

7.1.2 X4U/X5U

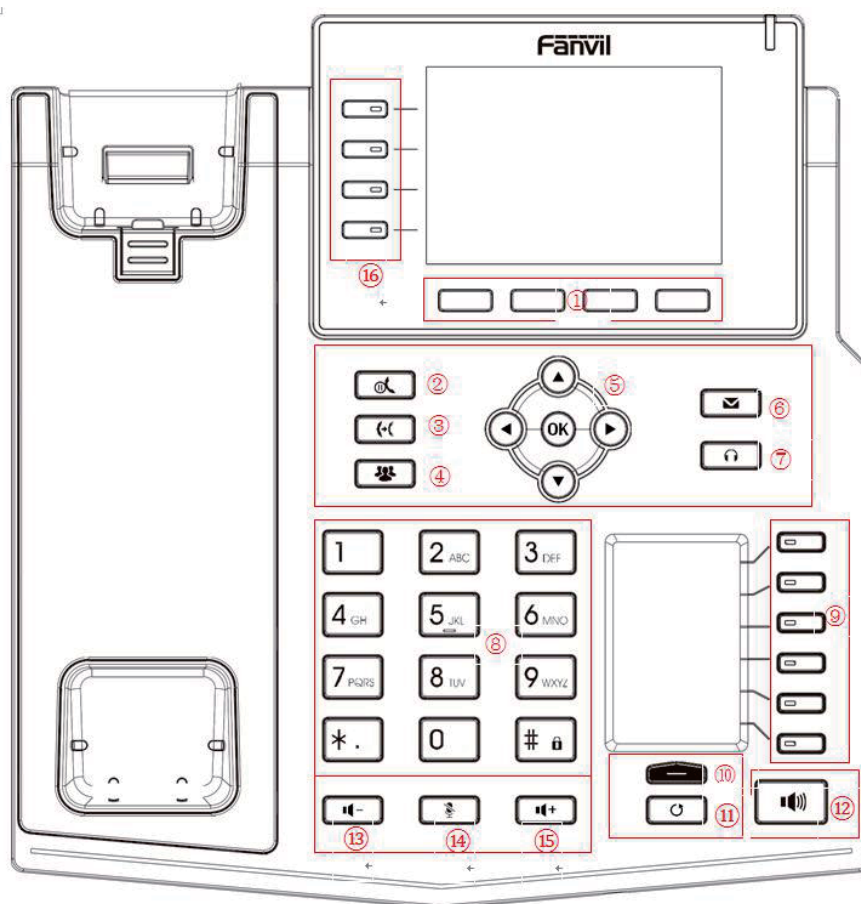

Picture 5 - Instruction of Keypad of X4U&X5U

Table 9 - Instruction of Keypad of X4U&X5U

Number	The keypad names	Instruction
①	Soft-menu Buttons	These four buttons provide different functions corresponding to the soft-menu displayed on the screen.
②	Hold Key	Press the "Hold" key during the call, the user can hold the call, and press it again to cancel the holding and restore the normal call state.
③	Transfer Key	Press the "Transfer" button, the user can transfer the current call to other numbers.
④	Conference	Press the "Conference" button, the user can initiate a three-party conference.
⑤	Navigate/OK Keys	The user can press the up/down navigation key to change the line or move the cursor in the screen list. On some Settings and text editing pages, the user can press the left/right navigation key to change options or move the cursor in the screen list to the left/right. OK key: Default is equivalent to soft button confirmation; user can

		customize the function.
⑥	voice mail	Press the "voice mail" button, and the user enters the interface of SMS and voice mail list.
⑦	Headset Key	Users can press this key to open the headset
⑧	Standard Telephone Keys	The 12 standard telephone keys provide the same function as standard telephones, but further to the standard function, some keys also provide special function by long-pressing the key, Key  - Long-pressed to lock the phone.
⑨	DSS KEY	Long press DSS key to enter the settings interface and set the required functions
⑩	Next Page Key	Users can switch the second screen page in turn. (X3U is not supported)
⑪	Redial	Press the Redial key to redial the last number dialed
⑫	Hands-free Key	The user can press this key to open the audio channel of the speakerphone.
⑬	Volume Down Key	In the standby state, ring and ring configuration interface, press this button to reduce the ring volume; Press this button to lower the volume on the call or volume adjustment screen.
⑭	Mute Key	During a call, the user can press this key to mute the microphone.
⑮	Volume Up Key	In the standby state, ring and ring configuration interface, press this button to increase the ring volume; Press this button to increase the volume on the call or volume adjustment screen.
⑯	Side Key	Long press the side key to enter the settings interface and set the required functions.

7.1.3 Instruction of Keypad of X6U

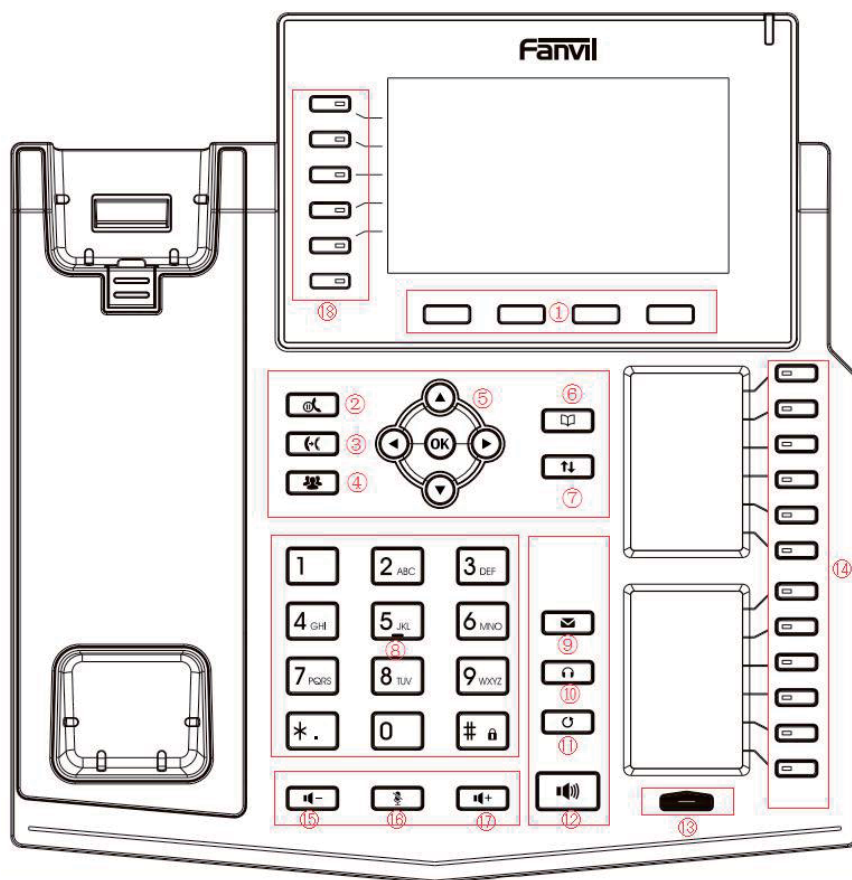

Picture 6 - Instruction of Keypad of X6U

Table 10 - Instruction of Keypad of X6U

Number	The keypad names	Instruction
①	Soft-menu Buttons	These four buttons provide different functions corresponding to the soft-menu displayed on the screen.
②	Hold Key	Press the "Hold" key during the call, the user can hold the call, and press it again to cancel the holding and restore the normal call state.
③	Transfer Key	Press the "Transfer" button, the user can transfer the current call to other numbers.
④	Conference	Press the "Conference" button, the user can initiate a three-party conference.
⑤	Navigate/OK Keys	The user can press the up/down navigation key to change the line or move the cursor in the screen list. On some Settings and text editing pages, the user can press the left/right navigation key to change options or move the cursor in the screen list to the left/right. OK key: Default is equivalent to soft button confirmation; user can customize

		the function.
⑥	Contact Key	Press the "Contact" key, the user can enter the address book interface and select the contact person to call.
⑦	Call Log Key	Press the "Call Log" button and the user can see the incoming/outgoing calls.
⑧	Standard Telephone Keys	The 12 standard telephone keys provide the same function as standard telephones, but further to the standard function, some keys also provide special function by long-pressing the key, Key # - Long-pressed to lock the phone.
⑨	Voice Mail	Press the "voice mail" button, and the user enters the interface of SMS and voice mail list.
⑩	Headset Key	Users can press this key to open the headset channel
⑪	Redial	Press the Redial key to redial the last number dialed
⑫	Hands-free Key	The user can press this key to open the audio channel of the speakerphone.
⑬	Next Page Key	Users can switch the second screen page in turn. (X3U is not supported)
⑭	DSS KEY	Long press DSS key to enter the settings interface and set the required functions
⑮	Volume Down Key	In the standby state, ring and ring configuration interface, press this button to reduce the ring volume; Press this button to lower the volume on the call or volume adjustment screen.
⑯	Mute Key	During a call, the user can press this key to mute the microphone.
⑰	Volume Up Key	In the standby state, ring and ring configuration interface, press this button to increase the ring volume; Press this button to increase the volume on the call or volume adjustment screen.
⑱	Side Key	Long press the side key to enter the settings interface and set the required functions.

7.2 Using Handset / Hands-free Speaker / Headphone

■ Using Handset

To talk over handset, user should lift the handset off the device and dial the number, or dial the number first, then lift the handset and the number will be dialed. User can switch audio channel to handset by lifting the handset when audio channel is turned on in speaker or headphone.

■ Using Hands-free Speaker

To talk over hands-free speaker, user should press the hands-free button then dial the number, or dial the number first then press the hands-free button. User can switch audio channel to the speaker from handset by pressing the hands-free button when audio channel is opened in handset.

■ Using Headphone

To use headphone, by default, user should headset button which is defined by DSS key to turn on the headphone. Same as handset and hands-free speaker, user can dial the number before or after the headphone is turned on.

■ Using Line Keys (Defined by DSS Key)

User can use line key to make or answer a call on specific line. If handset has been lifted, the audio channel will be opened in handset. Otherwise, the audio channel will be opened in hands-free speaker or headphone.

7.3 Idle Screen



Picture 7 - Screen layout/default home screen

The image above shows the default standby screen, which is the user interface most of the time.

The upper half of the home screen shows the status of the device, information and data that can be edited (such as voice messages, missed calls, auto answer, do not disturb, lock status, network connection status, etc.).

The lower half of the area are the function menu keys, which are also the first layer of function menu keys, through which users can operate the phone.

Users can restore the phone to the default standby screen interface by picking up and dropping the handle.

The left and right part of the area shows default configuration of Side keys, which dynamically display the configuration of SIP information, message, headset, etc., which can be customized by users.

The icon description is described in [6.1 appendix 1](#).

In some screens, there are many items or long text to be displayed which could not fit into the screen. They will be arranged in a list or multiple lines with a scroll bar. If the user sees a scroll bar, he can use up/down navigator buttons to scroll the list. By long-pressed the navigator keys, user can scroll the list or items in a faster speed.



Picture 8 - Scroll icon

7.4 Phone Status

The phone status includes the following information about the phone:

- Network Status:
 - VLAN ID
 - IPv4 or IPv6 status
 - IP Address
 - Network Mode
 - The Phone Device Information:
 - Mac Address
 - Phone Mode
 - Hardware Version number
 - Software Version number
 - Phone Storage (RAM and ROM)
 - System Running Time
 - SIP Account Information:
 - SIP Account
 - SIP Account Status (register / uncommitted / trying / time out)
 - TR069 Connect Status (Displays only in the phone interface state)
- The user can view the phone status through the phone interface and the web interface.
- Phone interface: When the phone is in standby mode, press **【Menu】** >> **【Status】** and select the option to view the corresponding information, as shown in the figure:

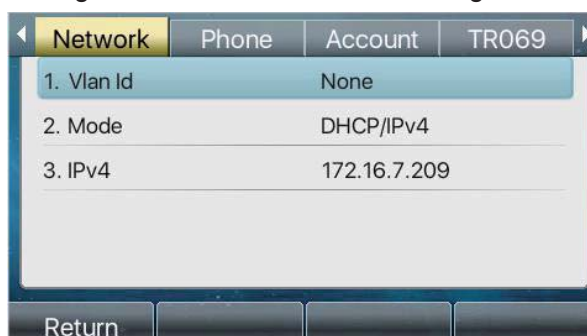

Picture 9 - The Phone status

- WEB interface: Refer to [7.5 Web management](#) to log in the phone page, enter the **【System】 >> 【Information】** page, and check the phone status, as shown in the figure:



Picture 10 - WEB phone status

7.5 Web Management

Phone can be configured and managed on the web page of the phone. The user needs to enter the IP address of the phone in the browser and open the web page of the phone firstly. The user can check the IP address of the phone by pressing **【Menu】 >> 【Status】**.



Picture 11 - Landing page

Users must correctly enter the user name and password to log in to the web page. The default user name and password are "admin". For the specific details of the operation page, please refer to page [11 Web configuration](#).

7.6 Network Configurations

The device relies on IP network connection to provide service. Unlike traditional phone system based on a circuit switched wire technology, IP devices are connected to each other over the network and exchange data in packet basis based on the devices' IP address.

To enable this phone, you must first correctly configure the network configuration. To configure the network, users need to find the phone function menu button **[Menu]** >> **[Advanced Settings]** >> **[Network]** >> **[Network]**.

The default password for advanced Settings is "123".

NOTICE! If user saw a  'WAN Disconnected' icon flashing in the middle of screen, it means the network cable was not correctly connected to the device's network port. Please check the cable is connected correctly to the device and to the network switch, router, or modem.

The device supports three types of networks, IPv4/IPv6/IPv4&IPv6

There are three common IP configuration modes about IPv4

- Dynamic Host Configuration Protocol (DHCP) – This is the automatic configuration mode by getting network configurations from a DHCP server. Users don't need to configure any parameters manually. All configuration parameters will be getting from DHCP server and applied to the device. This is recommended for the most users.
- Static IP Configuration – This option allows user to configure each IP parameters manually, including IP Address, Subnet Mask, Default Gateway, and DNS servers. This is usually used in a technical environment of network users.
- PPPoE - This option is often used by users who connect the device to a broadband modem or router. To establish a PPPoE connection, user should configure username and password provided by the service provider.

The device is default configured in DHCP mode.

There are three common IP configuration modes about IPv6

- DHCP - This is the automatic configuration mode by getting network configurations from a DHCP server. Users need not to configure any parameters manually. All configuration parameters will be getting from DHCP server and applied to the device. This is recommended for most users.
- Static IP configuration - this option allows users to manually configure each IP parameter, including IP address, mask, gateway, and primary and secondary domains. This usually applies to some professional network user environments.

Please see [10.7.2.1 network Settings](#) for detailed configuration and use.

7.7 SIP Configurations

A line must be configured properly to be able to provide telephony service. The line configuration is like a virtualized SIM card on a mobile phone which stores the service provider and the account information used for registration and authentication. When the device is applied with the configuration, it will register the device to the service provider with the server's address and user's authentication as stored in the configurations. The user can conduct line configuration on the interface of the phone or the webpage, and input the corresponding information at the registered address, registered user name, registered password and SIP user and registered port respectively, which are provided by the SIP server administrator.

- Phone interface: To manually configure a line, the user can press the line key for a long time, or press the button in the function menu [Menu] >> [Advanced Settings] >> [Accounts] >> [Line n] configuration, click ok to save the configuration.

NOTICE! User must enter correct PIN code to be able to advanced settings to edit line configuration. (The default PIN is 123)

The parameters and screens are listed in below pictures.

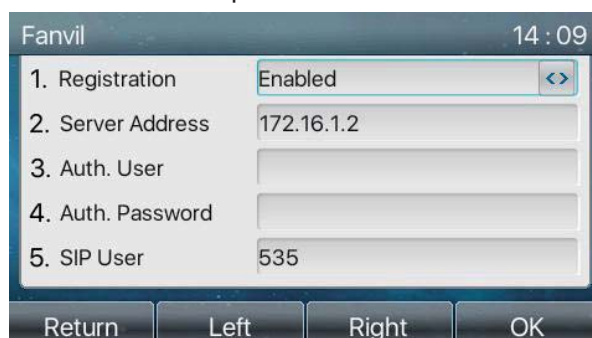

Picture 12 - Phone line SIP address and account information

- WEB interface: After logging into the phone page, enter [Line] >> [SIP] and select SIP for configuration, click apply to complete registration after configuration, as shown below:

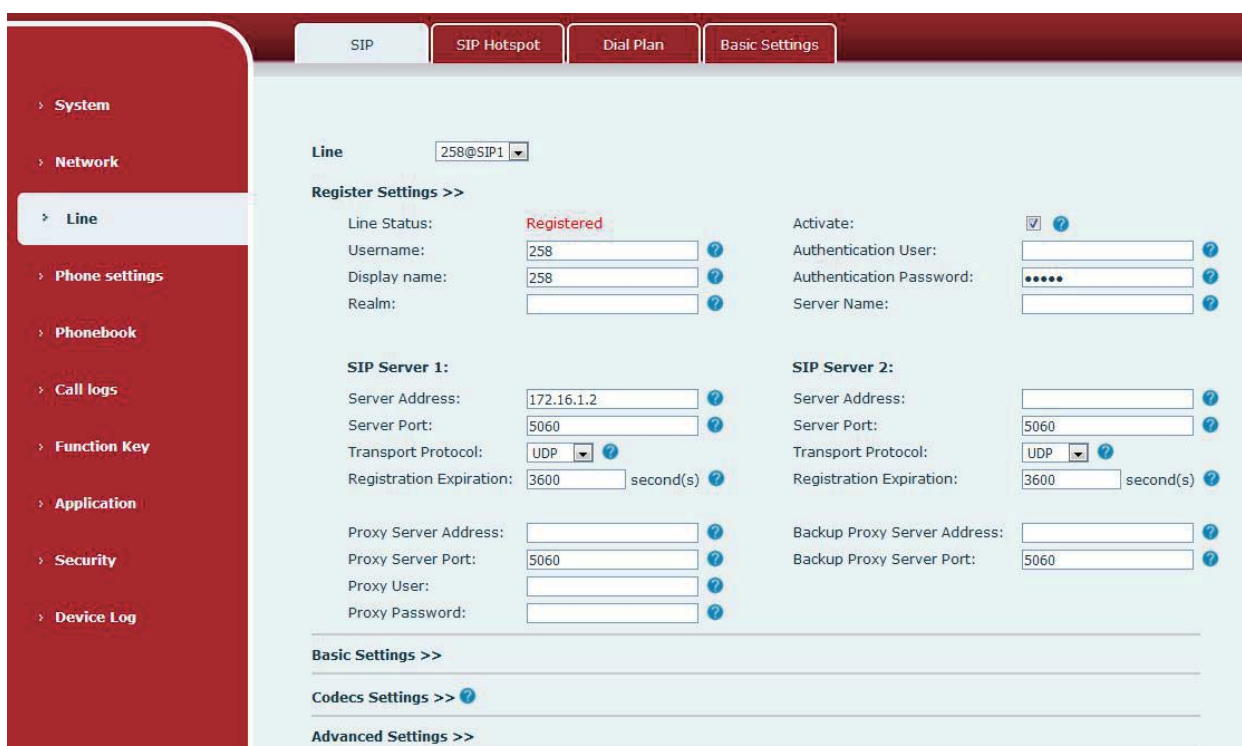

Picture 13 - Web SIP registration

8 Basic Function

8.1 Making Phone Calls

■ Default Line

The device provides twenty line services. If both lines are configured, user can make or receive phone calls on either line. If default line is configured by user, there will be a default line to be used for making outgoing call which is indicated on the top left corner. To change the default line, user can press left/right navigator buttons to switch between two lines. Enable or disable default line, user can press **[Menu]** >> **[Features]** >> **[General]** >> **[Default Line]** or configure from Web Interface (Web / PHONE / Features / Basic Settings).



Picture 14 - Default line

■ Dialing Methods

User can dial a number by,

- Entering the number directly
- Selecting a phone number from phonebook contacts (Refer to [10.2.1 Local contacts](#))
- Selecting a phone number from cloud phonebook contacts (Refer to [10.2.3 Cloud Phone Book](#))
- Selecting a phone number from call logs (Refer to [10.3 Call Log](#))
- Redialing the last dialed number

■ Dialing Number then Opening Audio

To make a phone call, user can firstly dial a number by one of the above methods. When the dialed number is completed, user can press **[Dial]** button on the soft-menu, or press hand-free button to turn on the speaker or headphone, or lift the handset to call out with the current line, or user can press line key (Configured by DSS Keys) to call out with specified line.

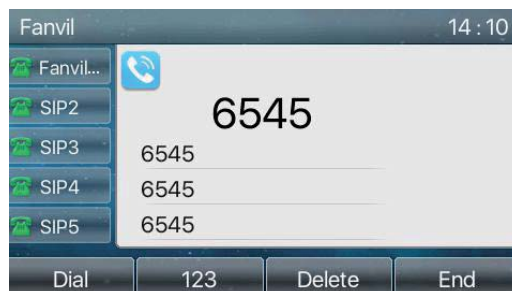

Picture 15 - Enable voice channel dialing

■ Opening Audio then Dialing the Number

Another alternative is the traditional way to firstly open the audio channel by lifting the handset, then turn on the hands-free speaker or headphone by pressing hands-free button, or line key, and then dial the number with one of the above methods. When completing the number dial, user can press **[Dial]** button or **[OK]** button to call out, or the number can also be dialed out automatically after timeout.

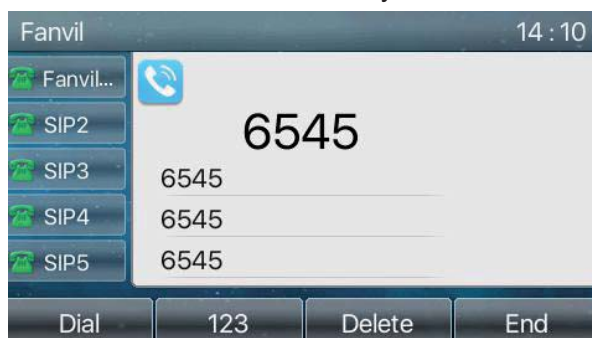

Picture 16 - Open the voice channel and dial the number

■ Cancel Call

While calling the number, user can stop the audio channel by putting back the handset or pressing the hands-free button to drop the call.

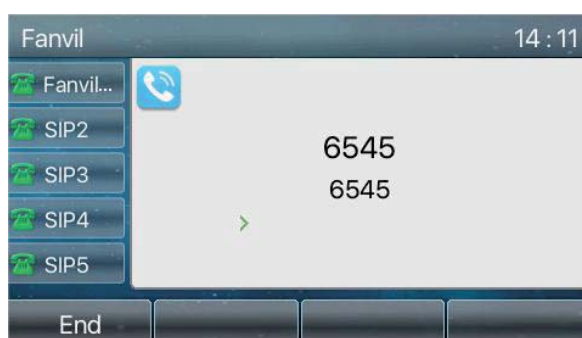

Picture 17 - Call number

8.2 Answering Calls

When there is an incoming call while the device is idle, user will see the following incoming call on the screen.

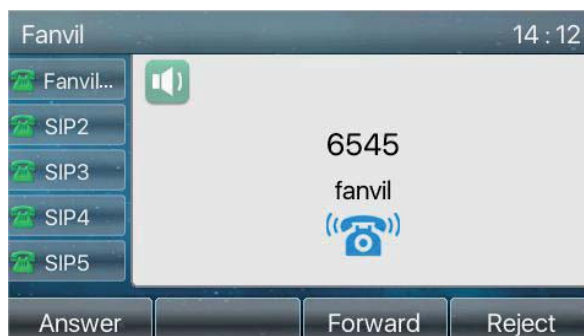

Picture 18 - Answering calls

User can answer the call by lifting the handset, open headphone or speaker phone by pressing the hands-free button, or the **[Answer]** button. To divert the incoming call, user should press **[Divert]** button. To

reject the incoming call, user should press [Reject] button.

8.2.1 Talking

When the call is connected, user will see a talking mode screen as the following figure.

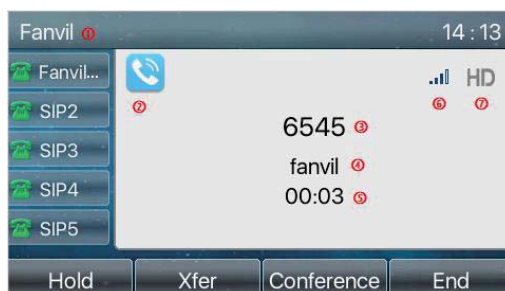

Picture 19 - Talking interface

Table 11 - Talking mode

Number	Name	Description
①	Default line	The line currently used by the phone.
②	Voice channel	The icon shows the voice channel mode being used.
③	Calls to end	The name or number of the person on the other end of the call.
④	Call duration	The duration of a call after it has been established.
⑤	Numbers of line	Shows how many calls are present on the current device
⑥	Speech quality	Displays the current voice quality of the call.
⑦	HD audio	Call using G.722 voice coding calls when displayed HD voice icon.

8.2.2 Make / Receive Second Call

The device can support up to two concurrent calls. When there is already a call established, user can still answer another incoming call on either lines or make a second call on either lines.

■ Second Incoming Call

When there is another incoming call during talking a phone call, this call will be waiting for user to answer. User will see the call message in the middle of current screen. The device will not be ringing but playing call waiting tone in the audio channel of the current call and the LED will be flashing in green. User can accept or reject the call as same as normal incoming call. When the waiting call is answered, the first call will be held on automatically.



Picture 20 - The second call interface

■ Second Outgoing Call

To make a second call, user may press [Xfer] / [Conf] button to make a new call on the default line or press the line key to make new call on specific line. Then dial the number the same way as making a phone call. Another alternative for making second call is to press DSS Keys or dial out from the configured Keys (BLF/Speed Dial). When the user is making a second call with the above methods, the first call could be held on manually or will be held on automatically at second dial.

■ Switching between Two Calls

When there are two calls established, user will see a dual calls screen as the following picture.



Picture 21 - Two way calling

User can press up/down navigator buttons to switch screen page, and switch call focus by pressing [Resume] button.

■ Ending One Call

User may hang up the current talking call by closing the audio channel or press [End] button. The device will return to single call mode in holding state.

8.3 End of the Call

After the user finishes the call, the user can put the handle back on the phone, press the hands-free button or Softkey [End] key to close the voice channel and end the call.

Note! When the phone is in the reserved state, the user must press the [Resume] key to return to the call state, or put the receiver back and press the hands-free button to end the call.

8.4 Redial

- Redial the last outgoing number:
When the phone is in standby mode, press the redial button and the phone will call out the last outgoing number.
- Call out any number with the redial key:
Enter the number, press the redial key, and the phone will call out the number on the dial.
- Press the redial key to enter the call record:
Log in the phone page, enter [Phone Settings] >> [Features] >> [Redial Settings], check **Redial** to enter the call record page, press the redial button when standby to enter the call record page, and press

again to call out the current located number.

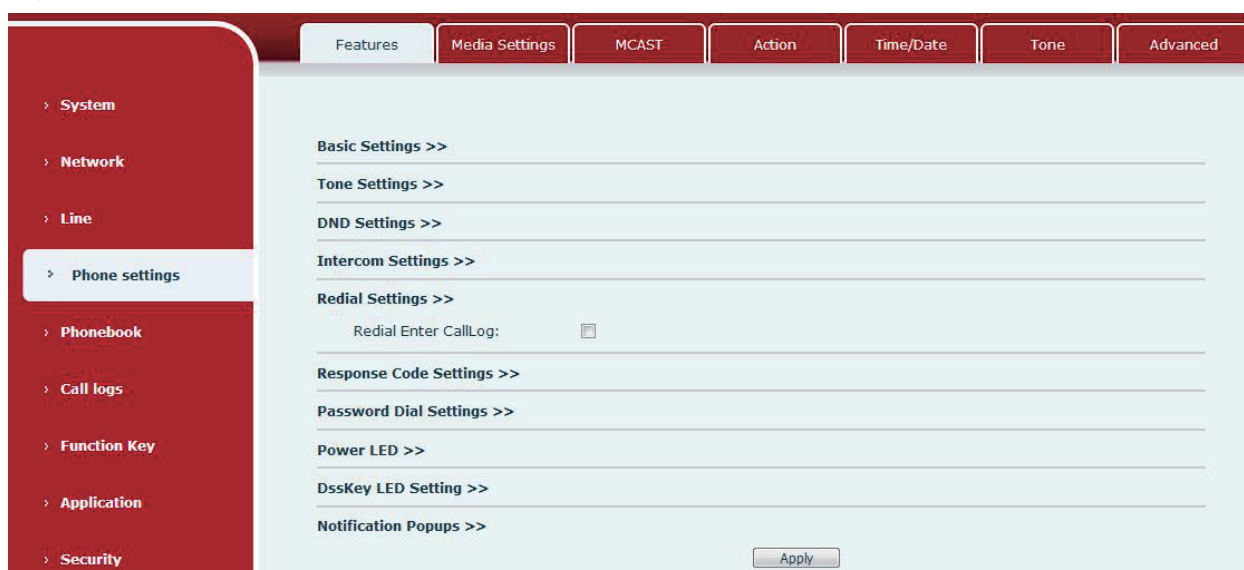

Picture 22 - Redial set

8.5 Dial-up Query

The phone is defaulted to turn on the dial-up inquiry function, dial-out, enter two or more numbers. The dial interface will automatically match the call records, contacts in the number list. Use the navigation key and up and down keys to select the number, press the call out key or wait for time out.

8.6 Auto-Answering

User may turn on the auto-answering mode on the device and any incoming call will be automatically answered (not including call waiting). The auto-answering can be enabled on line basis.

The user can start the automatic answer function in the telephone interface or the webpage interface.

- **Phone interface:**

Press [**Menu**] >> [**Features**] >> [**Auto Answer**] button;

Press the button to select the line, use the left/right navigation key to turn on/off the auto answer option, and set the auto answer time to 5 seconds by default.

After completion, press [**OK**] key to save;



The icon in the upper right corner of the screen indicates that auto answer is enabled.

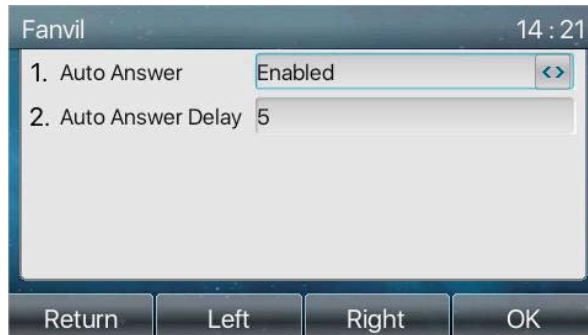

Picture 23 - Line 1 enables auto-answering



Picture 24 - The line has enabled auto-answering

- **WEB interface:**

Log in the phone page, enter [Line] >> [SIP], select [SIP] >> [Basic settings], start auto-answering, and click apply after setting the automatic answering time.

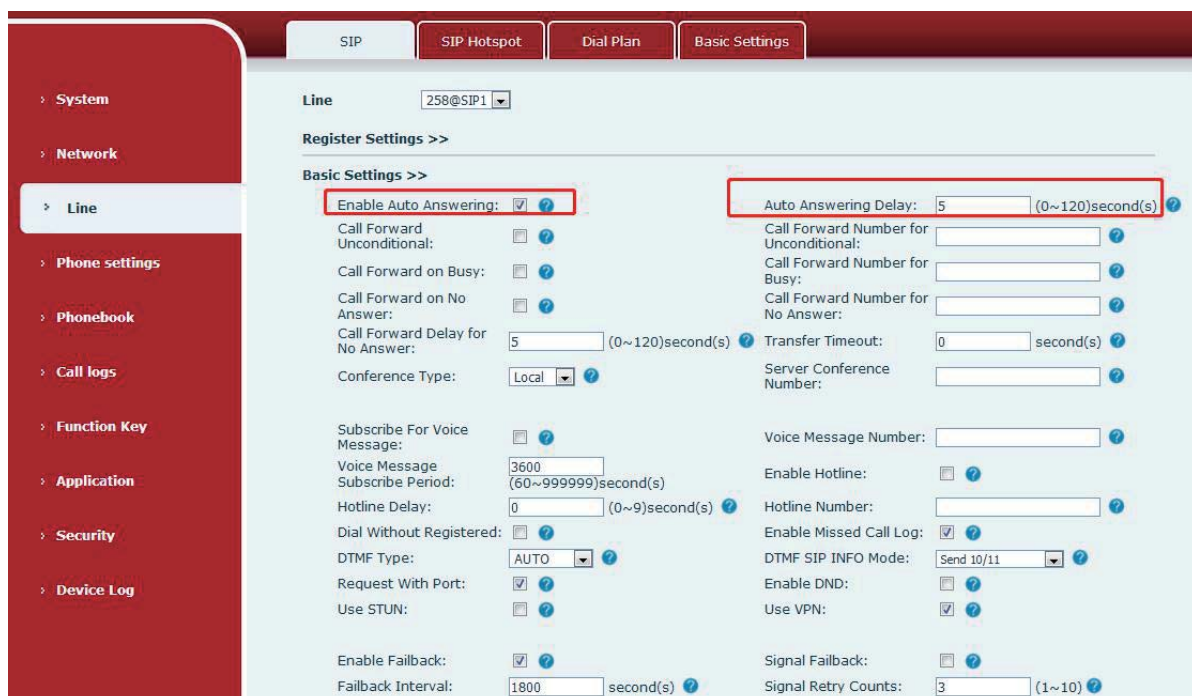

Picture 25 - Web page to start auto-answering

8.7 Callback

The user can dial back the number of the last call. If there is no call history, press the **[Callback]** button and the phone will say "can't process".

- Set the callback key through the phone interface:
Under standby, press **[Menu]** >> **[Basic Settings]** >> **[Keyboard Settings]** >> **[Function key]** or **[Keyboard Settings]** >> **[Soft function key]** choose to set up the function keys, key type, type selection function name select callback function, input the callback key name, press **[OK]** key to save.

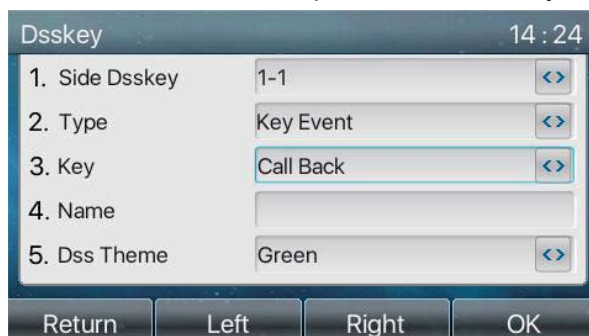

Picture 26 - Set the callback key on the phone

- Set the callback key through the web interface:
Log in the phone page, enter the **[Function Key]** >> **[Side Key]** or **[Function Key]** >> **[Function Key]** page, select the function Key, set the type as the function Key, and set the subtype as the callback, as shown in the figure:

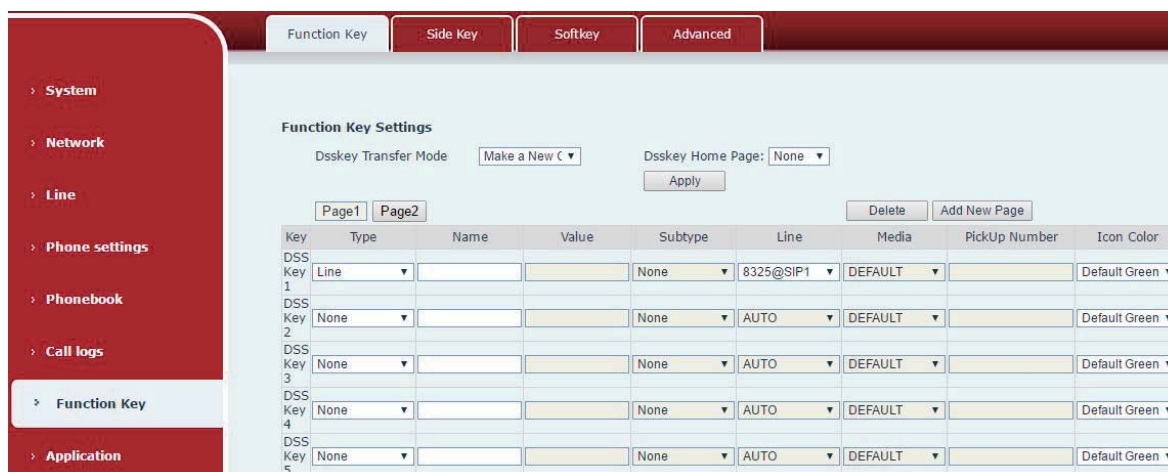

Picture 27 - Set the callback key on the web page

8.8 Mute

You can turn on mute mode during a call and turn off the microphone so that the local voice is not heard. Normally, mute mode is automatically turned off at the end of a call. You can also turn on mute on any screen (such as the free screen) and mute the ringtone automatically when there is an incoming call. Mute mode can be turned on in all call modes (handles, headphones or hands-free).

8.8.1 Mute the Call

- During the conversation, press the mute button on the phone:  the mute button on the phone will turn on the red light.

Red mute icon is displayed in the call interface, as shown in the figure:



Picture 28 - Mute the call

- Cancel mute: press  cancel mute on the phone again. The mute icon is no longer displayed in the call screen. The red light is off by mute button.



8.8.2 Ringing Mute

- Mute: press the mute button when the phone is in standby mode: 

The top right corner of the phone shows the bell mute icon , Mute button red light is always on, when there is an incoming call, the phone will display the incoming call interface but will not ring.



Picture 29 - Ringing mute

- Cancel ring tone mute: On the standby or incoming call screen, press the mute button again  or volume up  cancel ring tone mute, no longer shows mute icon in upper right corner after cancel . The phone mute icon is off.

8.9 Call Hold/Resume

The user can press the [**Hold**] button to maintain the current call, and this button will become the [**Resume**] button, and the user can press the "resume" button to restore the call.

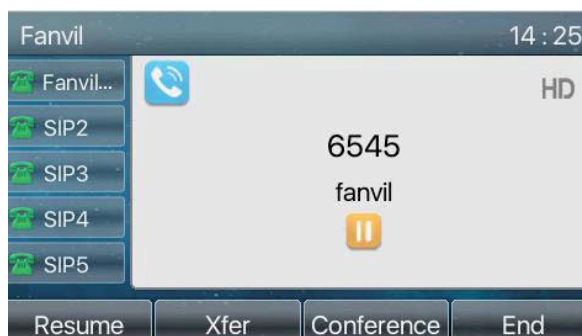

Picture 30 - Call hold interface

8.10 DND

User may enable Do-Not-Disturb (DND) feature on the device to reject incoming calls (including call waiting). The DND can be enabled on line basis.

Enable/Disable phone all lines DND, the methods as the following:

- Phone interface: Default standby mode,
 - 1) Press [**DND**] button to enter the DND setting interface, select line or phone to enable DND.
 - 2) Press [**DND**] button to enter the DND setting interface and disable DND.



Picture 31 - Enable DND

If the user wants to enable/disable the uninterrupted function on a specific line, the user can set the uninterrupted function on the page of configuring the line.

- 1) Press [**Menu**] >> [**Features**] >> [**DND**] button, Enter the [**DND**] to edit the interface.
- 2) Click the left/right navigation button to select the line to adjust the mode and state of "do not disturb", and then press the [**OK**] button to save.

The user will see the DND icon turn red, and the sip-line has enabled the mode of "DND".

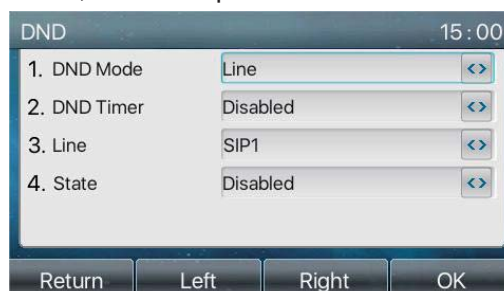

Picture 32 - DND setting interface

The user can also use the DND timer. After the setting, the DND function will automatically turn on and the DND icon will turn red when ringing.

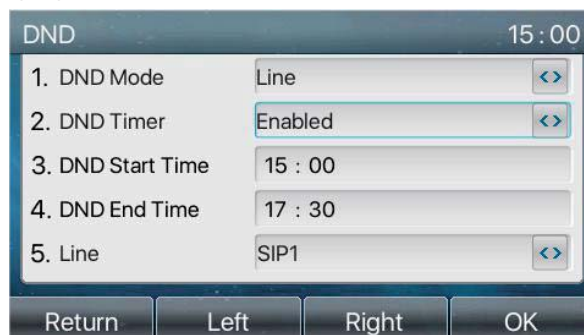

Picture 33 - DND timer

- WEB interface: Enter [Phone setting] >> [Features] >> [DND settings], set the DND type (off, phone, line), and DND timing function.

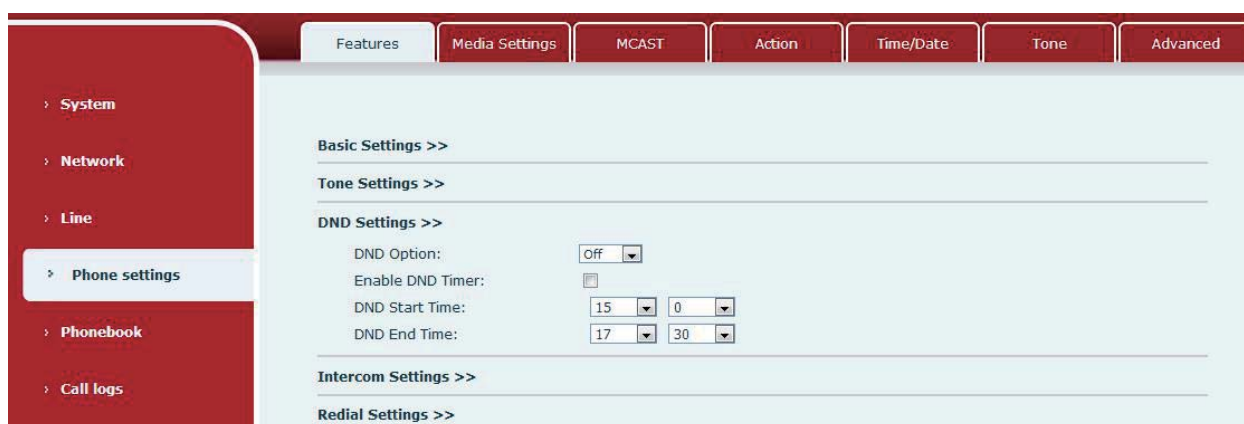

Picture 34 - DND Settings

The user turns on the DND for a specific route on the web page: Enter [Line] >> [SIP], select a [Line] >> [Basic settings], and enable DND.

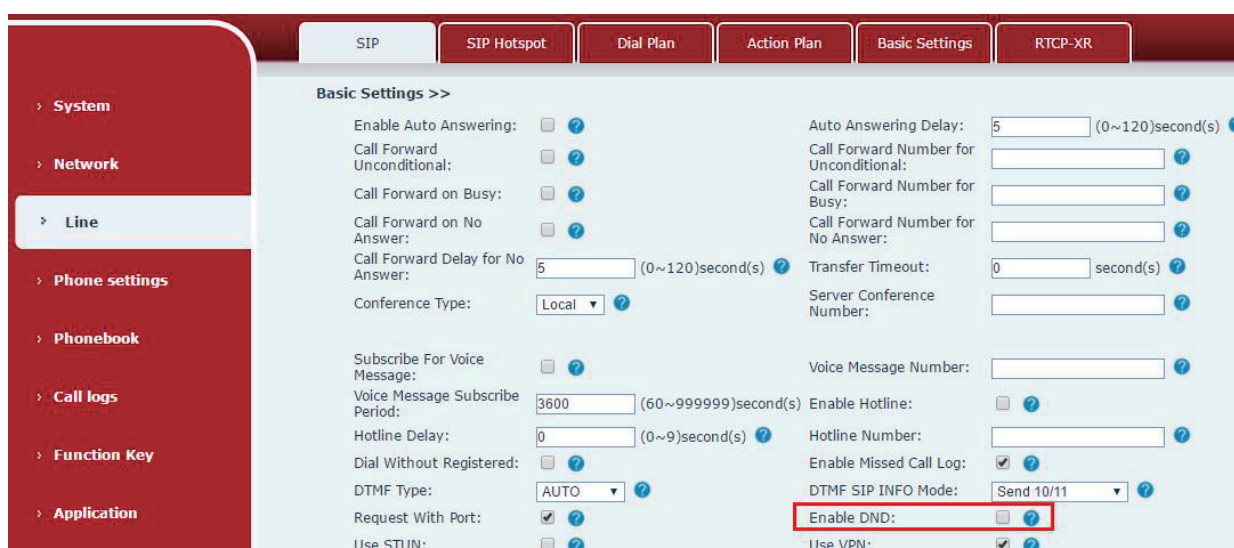

Picture 35 - Line DND

8.11 Call Forward

Call forward is also known as 'Call Divert' which is to divert the incoming call to a specific number based on the conditions and configurations. User can configure the call forward settings of each line.

There are three types,

- **Unconditional Call Forward** – Forward any incoming call to the configured number.
- **Call Forward on Busy** – When user is busy, the incoming call will be forwarded to the configured number.
- **Call Forward on No Answer** – When user does not answer the incoming call after the configured delay time, the incoming call will be forwarded to the configured number.
- Phone interface: Default standby mode
 - 1) Press **[Menu]** >> **[Features]** >> **[Call Forward]** button, select the line by up/down navigation key, press **[OK]** button to set call forward.

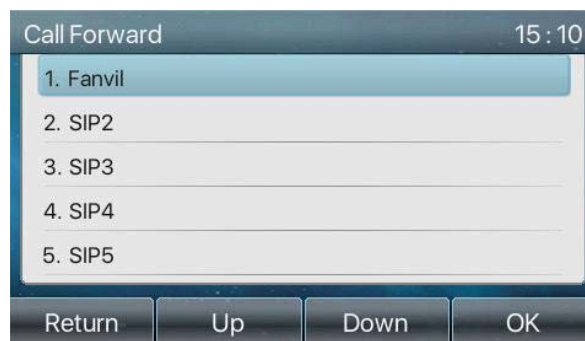

Picture 36 - Select the line to set up call forwarding

- 2) Select the call forward type by pressing the up/down navigation button. Click **[OK]** to configure call forwarding and delay time.

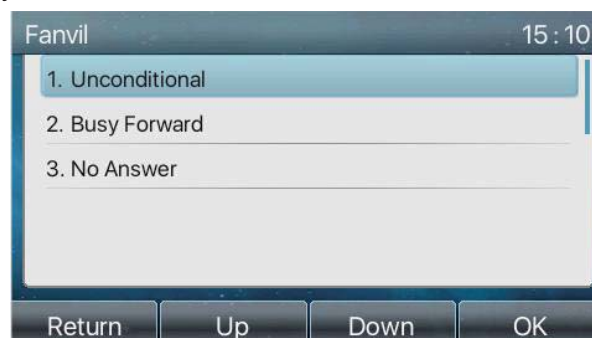

Picture 37 - Select call forward type

- 3) Select enable/disable by pressing the left/right navigation button.

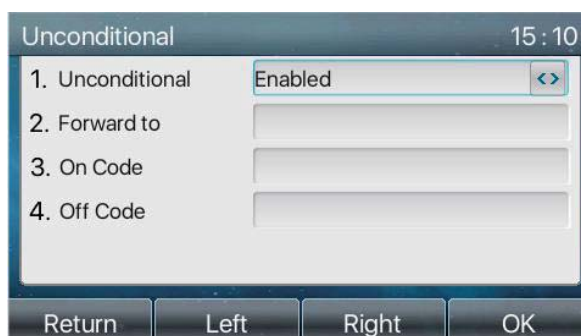

Picture 38 - Enable call forwarding and configure the call forwarding number

- 4) Browse the parameters set by the up/down navigation key and enter the required information. When finished, press the [OK] button to save the changes.
- WEB interface: Enter [Line] >> [SIP], Select a [Line] >> [Basic settings], and set the type, number and time of forward forwarding.

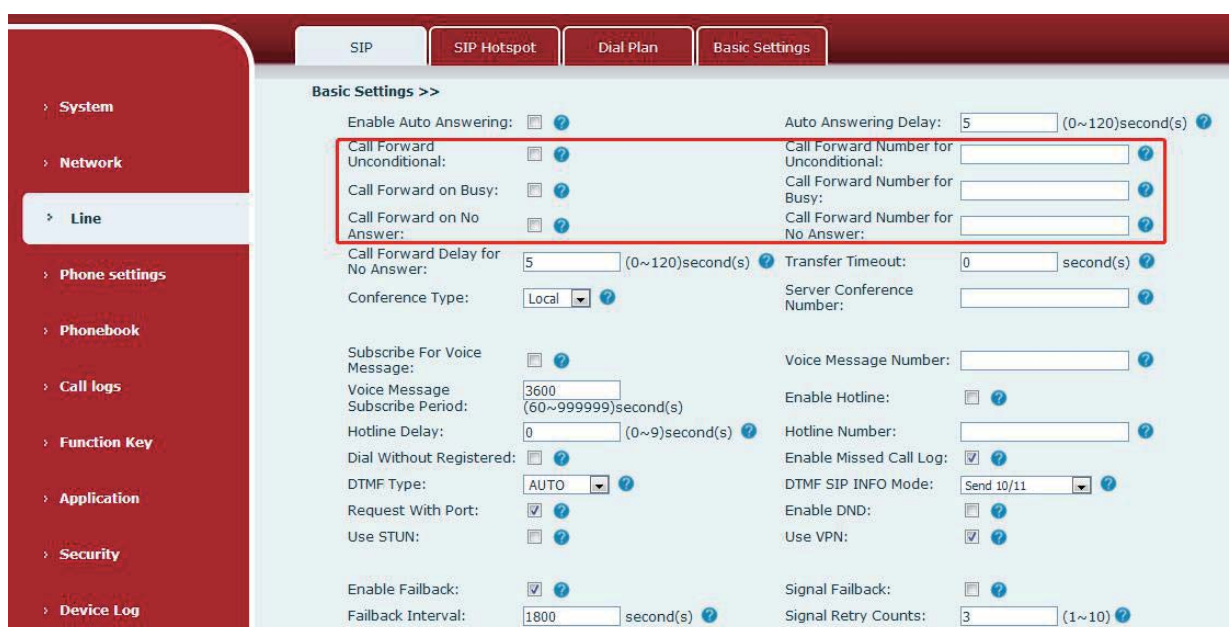

Picture 39 - Set call forward

8.12 Call Transfer

When the user is talking with a remote party and wish to transfer the call to another remote party, there are three way to transfer the call, blind transfer, attended transfer and Semi-Attended transfer.

- Blind transfer: No need to negotiate with the other side, directly transfer the call to the other side.
- Semi-Attended transfer: When you hear the ring back, transfer the call to the other party.
- Attended transfer: When the caller answers the call, transfer the call to the other party.

Note! For more transfer Settings, please refer to [12.6 Line >> Dial Plan](#)

8.12.1 Blind transfer

During the call, the user presses the function menu button [Transfer] or the transfer button on the phone , Enter the number to transfer or press the contact button or the history button to select the number, press the

transfer key again or blind transfer  to a third party. After the third party rings, the phone will show that the transfer is successful and hang up.

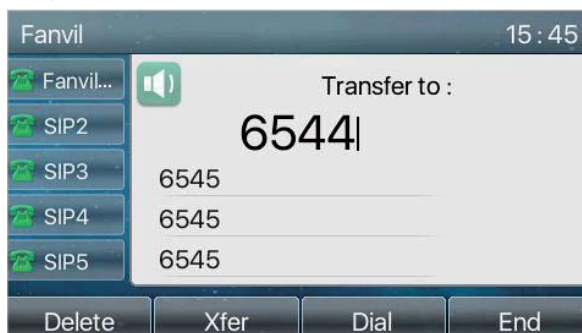

Picture 40 - Transfer interface

8.12.2 Semi-Attended transfer

During the call, the user presses the function menu button [transfer] or the transfer button  on the phone to input the number to be transferred or press the contact button or the historical record button to select the number, and then press the call button. When the third party is not answered, press the transfer on the call interface to make the semi-attendance transfer or press the end button to cancel the semi-attendance transfer.

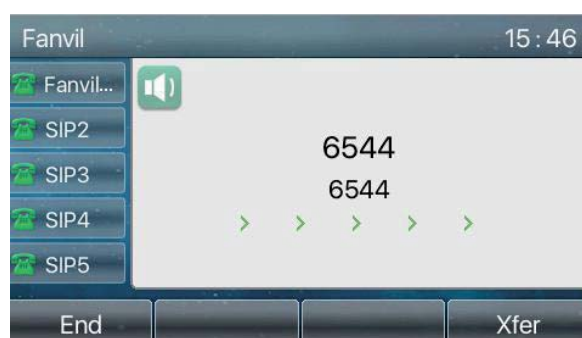

Picture 41 - Semi-Attended transfer

8.12.3 Attended transfer

Attendance transfer is also known as "courtesy mode", which is to transfer the call by calling the other party and waiting for the other party to answer the call.

The same procedure to calling. In dual call mode, press the "transfer" button to transfer the first call to the second call.

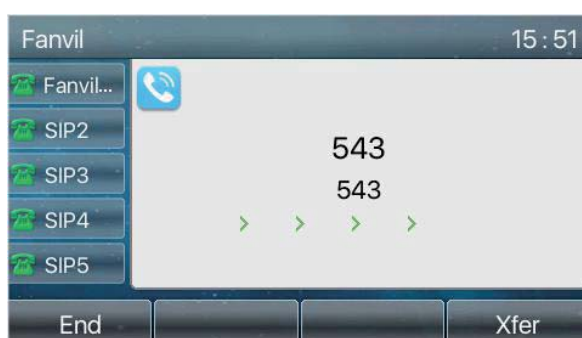

Picture 42 - Attended transfer

8.13 Call Waiting

- Enable call waiting: new calls can be accepted during a call.
- Disable call waiting: new calls will be automatically rejected and a busy tone will be prompted.
- Enable call waiting tone: when you receive a new call on the line, the tone will beep.
- The user can enable/disable the call waiting function in the phone interface and the web interface.
- Phone interface: Press **[Menu]** >> **[Features]** >> **[Call waiting]**, the navigation key and left/right button enable/disable call waiting and call waiting tone. Press **[Menu]** >> **[Features]** >> **[Call waiting]**, the navigation key and left/right button enable/disable call waiting and call waiting tone.



Picture 43 - Call waiting setting

- WEB interface: Enter **[Phone Settings]** >> **[Features]** >> **[Basic Settings]**, enable/disable call waiting and call waiting tone.

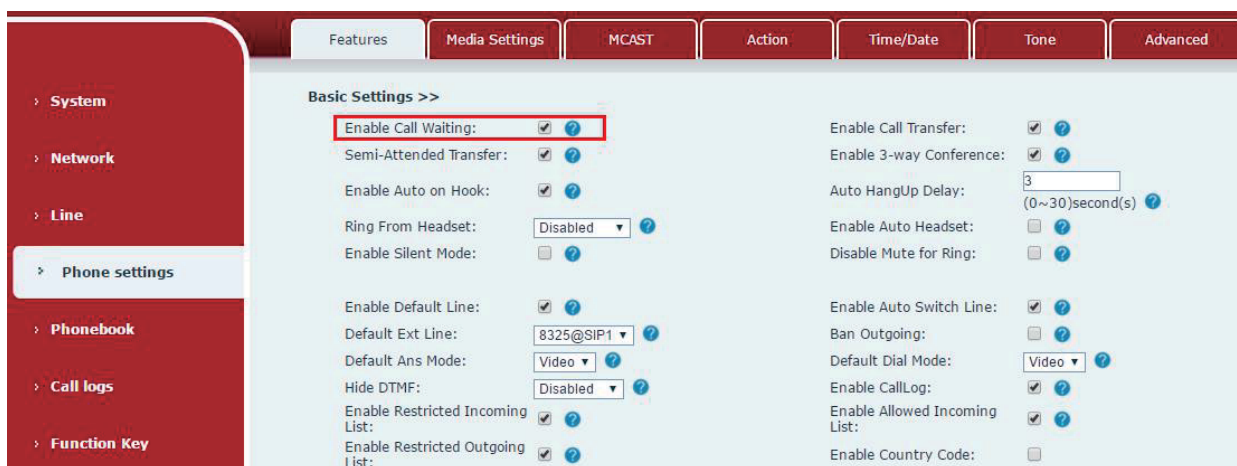

Picture 44 - Web call waiting setting

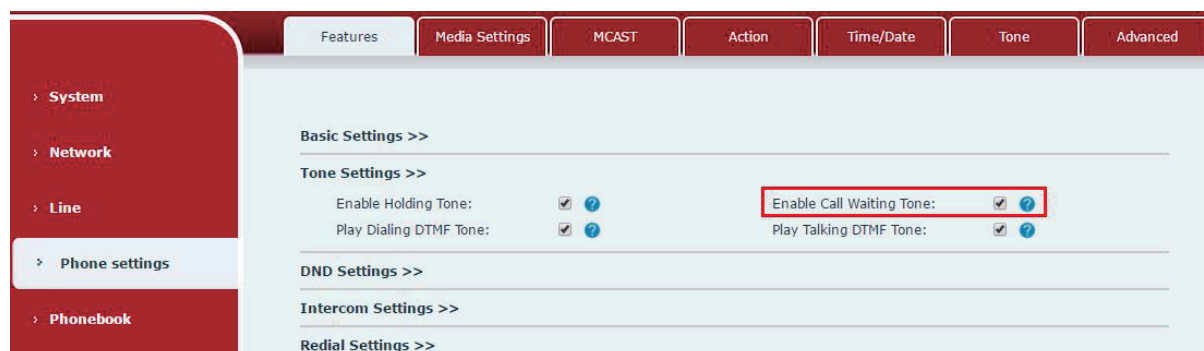

Picture 45 - Web call waiting tone setting

8.14 Conference

8.14.1 Local Conference

To conduct local conference, the user needs to log in the webpage and enter [Line] >> [SIP] >> [Basic settings]. The meeting mode is set as local (the default is local mode), as shown in the figure:

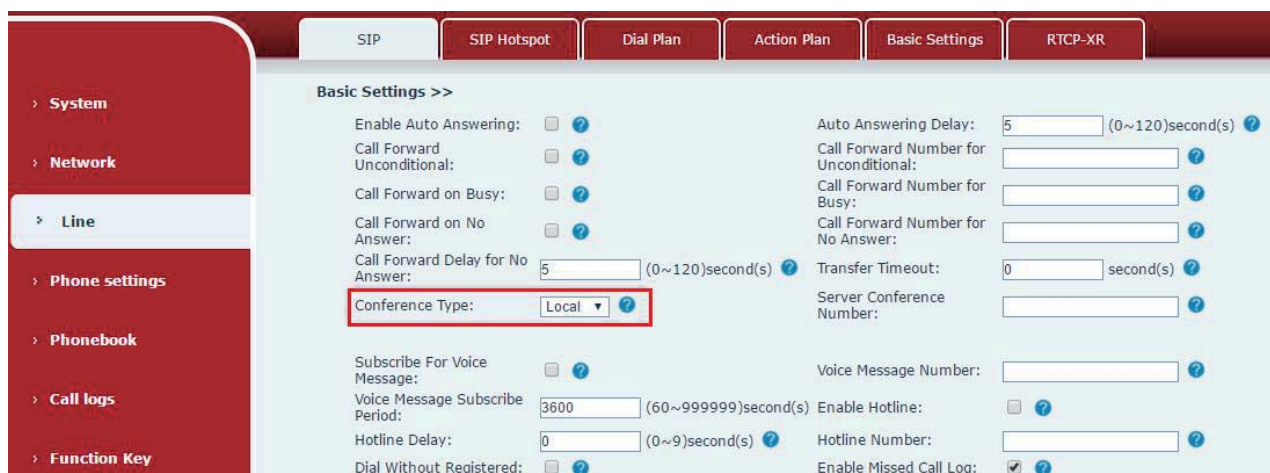

Picture 46 - Local conference setting

Two ways to create a local conference:

- 1) The device has two channels of communication. Press the conference button on the call interface. When selecting the conference number, select the other number that already exists.

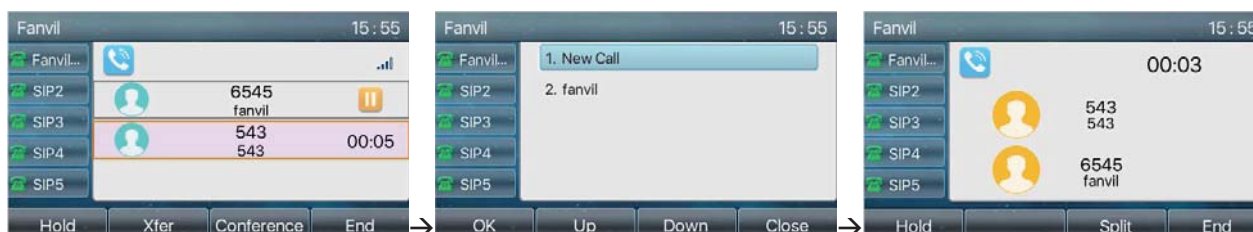

Picture 47 - Local conference (1)

- 2) If the device has a call all the way, press the conference key in the call interface, enter the number to join the meeting and press the call; After the opposite end is answered, press the conference button again to set up the local tripartite conference:



Picture 48 - Local conference (2)

Note: During the conference, press the split button to split the conference and press the end button to end the call.

8.14.2 Network Conference

Users need server support for network conference.

Log in the web page, enter [Line] >> [SIP] >> [Basic settings], set the conference mode as server mode (default is local mode), set the server conference room number (please consult your system administrator), as shown in the figure:



Picture 49 - Network conference

Method to join a network conference:

- Multi-party call number of network conference room and enter the password then all enter the conference room.
- The two phones have established common calls. Press the conference button to invite new members to the conference. Follow the voice prompt to operate.

Note: the upper limit of the number of participants in the network conference varies according to the server.

8.15 Call Park

Call park requires server support. Consult your system administrator for support.

When you are on the call, if it is not convenient to answer the phone at this time, you can press the configured park button to hold the call; After a successful park, you can resume the call by pressing the configured park button on other devices.

Set the call park button:

- Phone interface: long press a function key to enter the function key Settings interface, or through the **[Menu] >> [Basic Settings] >> [Keyboard Settings]** enter the settings interface of function keys, and set the key function type as memory and subtypes as call park, reside values for the server calls park number, set up corresponding SIP lines.
- WEB interface: log in the phone page, enter the **[Function Key] >> [Function Key]** page, select a DSSkey, set the function key type as memory key, the subtype as call park, and the value as the call park number of the server, and set the corresponding SIP line.

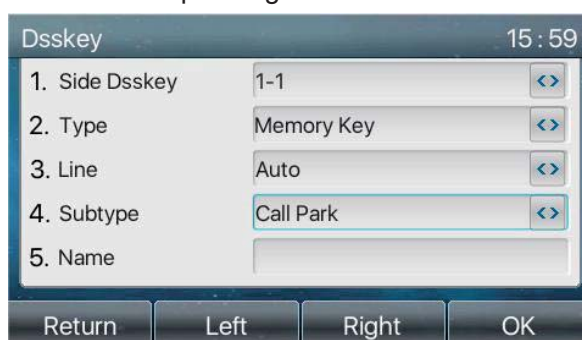

Picture 50 - Phone set call park

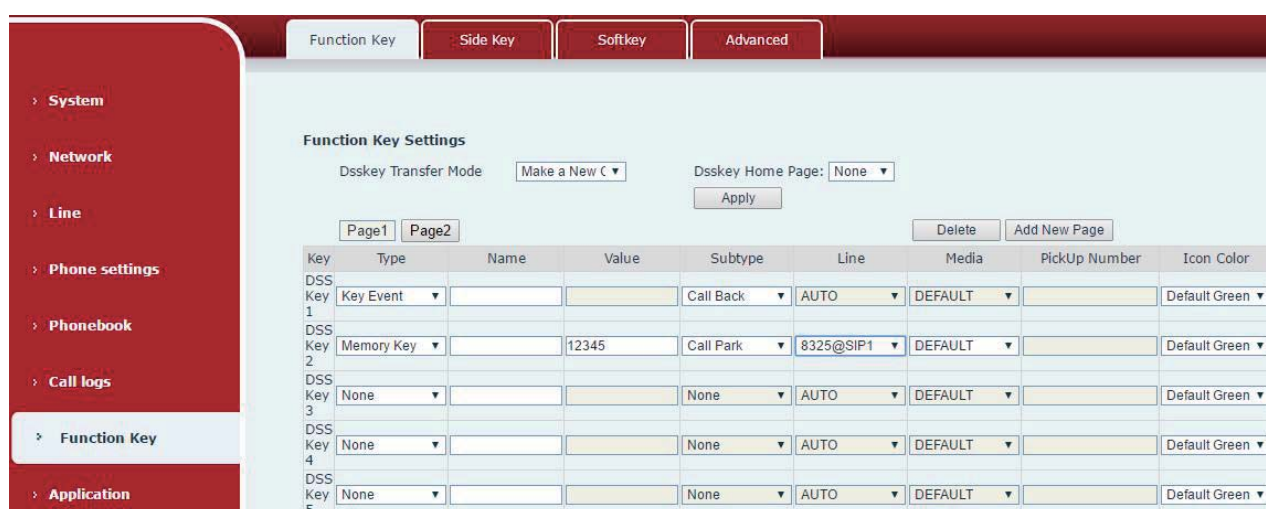

Picture 51 - WEB set call park

8.16 Pick Up

Pick up requires server support. Consult your system administrator for support.

You can use the Pick Up function to answer incoming calls from other users. The phone can pick up incoming calls by configuring DSSkey for BLF and setting the Pick Up code.

Phone interface: press **[Menu] >> [Basic Settings] >> [Keyboard Settings] >> [DSS Key Settings]**, select the function key to set.

- Set the line, function key type as memory key, subtype as BLF/NEW CALL, set subscription number, and pick up code.
- Other phones call the subscription number, and the opposite end is in the incoming ring.

- Press the DSS key to pick up the phone.
- The caller picks up the call and speaks to it.

WEB interface: Log in the phone webpage, enter the [Function Key] >> [Function Key] page, select a DSSkey, set the memory key type as memory key, the subtype as BLF/NEW CALL, and set the corresponding SIP line and pick up codes.

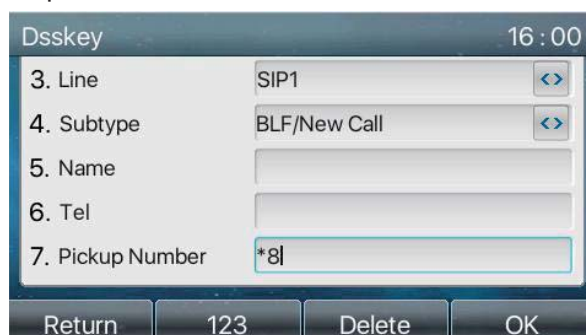

Picture 52 - Phone pick up setting

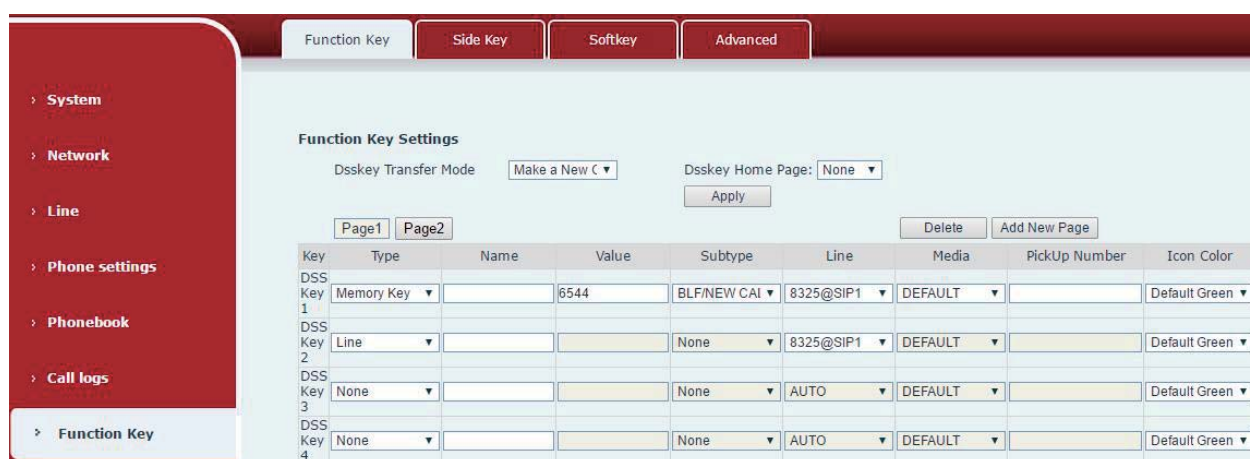

Picture 53 - WEB pick up setting

8.17 Anonymous Call

8.17.1 Anonymous Call

The phone can set up anonymous calls to hide the calling number and the calling name.

- You can see anonymity in the context of [Menu] >> [Advanced Settings] >> [Accounts] >> [Advanced].
- The default is none, which is off, and RFC3323 and RFC3325 are optional.
- Select any one to open the anonymous call.

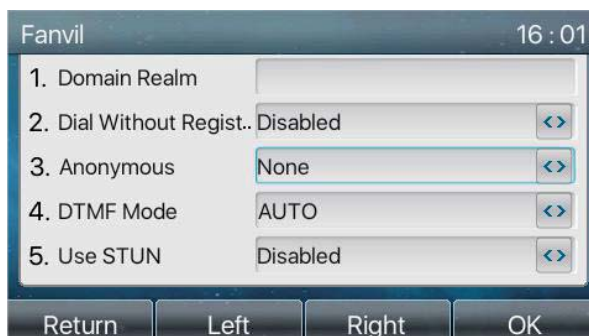

Picture 54 - Enable anonymous call

- On the web page [Line] >> [SIP] >> [Advanced Settings] can also open the mode of anonymous calls.
- Setting to enable anonymous calls also corresponds to the SIP line. That is, the setting under the SIP1 page can only take effect on the SIP1 line.

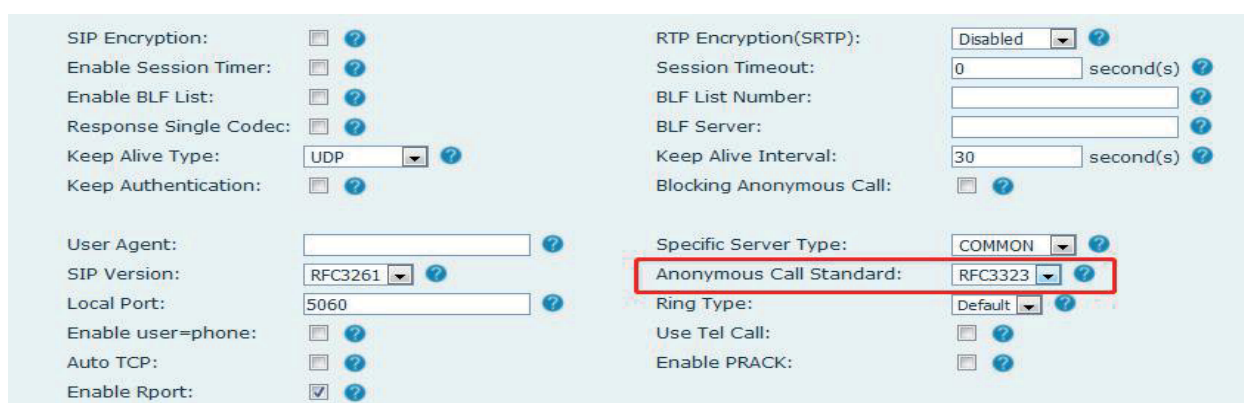

Picture 55 - Enable Anonymous web page call

The following is a transcript of an anonymous call received by the phone.



Picture 56 - Anonymous call log

8.17.2 Ban Anonymous Call

The device can be set to prohibit anonymous calls, that is anonymous calls to the number will be directly rejected.

- In the phone [Menu] >> [Features] >> [Ban anonymous call], click to enter and all SIP lines will be displayed.
- Click Softkey [Switch] or [<] [>] to switch the SIP line and enable anonymous call.

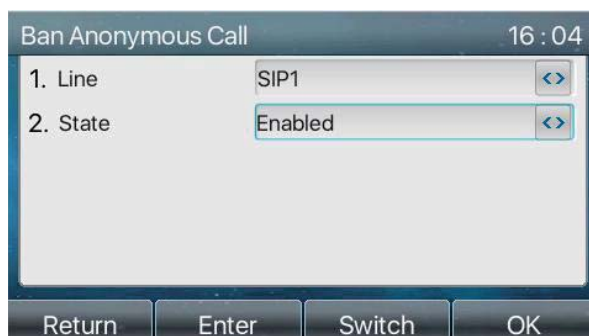

Picture 57 - Anonymous calls are not allowed on the phone

- On the web page [Line] >> [SIP] >> [Advanced Settings], also can disable anonymous calls.
- The setup to disable anonymous calls also corresponds to the SIP line. That is, the setting under the SIP1 page can only take effect on the SIP1 line.



Picture 58 - Page Settings blocking anonymous call

8.18 Hotline

The device supports hotline dialing. After setting up the hotline dialing, directly pick up the handset, hands-free, earphone, etc., and the phone will automatically call according to the hotline delay time.

- In the phone [Menu] >> [Features] >> [Advanced] >> [Hotline], click to enter and all SIP lines will be displayed.
- Then set the hotline for each SIP line, which is off by default.
- Open the hotline, set the hotline number, set the delay time of the hotline.



Picture 59 - Phone hotline setting interface

- On the website [Line] >> [SIP] >> [Basic Settings], can also set up a hotline.
- The setup hotline also corresponds to the SIP line. That is, the hotline set in the SIP1 webpage can only be activated in the SIP1 line.

Line: 258@SIP1

Register Settings >>

Basic Settings >>

Enable Auto Answering: ?

Call Forward Unconditional: ?

Call Forward on Busy: ?

Call Forward on No Answer: ?

Call Forward Delay for No Answer: 5 (0~120)second(s) ?

Conference Type: Local ?

Subscribe For Voice Message: ?

Voice Message: 3600

Subscribe Period: (60~999999)second(s)

Hotline Delay: 0 (0~9)second(s) ?

Dial Without Registered: ?

DTMF Type: AUTO ?

Request With Port: ?

Use STUN: ?

Auto Answering Delay: 5 (0~120)second(s) ?

Call Forward Number for Unconditional: ?

Call Forward Number for Busy: ?

Call Forward Number for No Answer: ?

Transfer Timeout: 0 second(s) ?

Server Conference Number: ?

Voice Message Number: ?

Enable Hotline: ?

Hotline Number: ?

Enable Missed Call Log: ?

DTMF SIP INFO Mode: Send 10/11 ?

Enable DND: ?

Use VPN: ?

Picture 60 - Hotline set up on webpage

8.19 Emergency Call

The emergency call function is used to set the corresponding emergency call number on the phone after enabling the keypad lock. You can also call emergency services when your phone is locked.

- 1) Configure the emergency call number: log in the phone page, enter the **[Phone Settings]** >> **[Function Settings]** >> **[Basic Settings]** page, set up the emergency call code, if you need to set up more than one emergency call code, please use ", " to separate.

Allow IP Call: ?

Caller Name Priority: LocalContact-NetContact-SIP DisplayName ?

Search path: LDAP ?

Caller Display Type: Normal ?

Restrict Active URI Source IP: ?

Enable Pre-Dial: ?

Line Display Format: xxx@SIPn ?

Block XML When Call: Enable ?

Call Number Filter: ?

P2P IP Prefix: .

Emergency Call Number: 110 ?

LDAP Search: LDAP 1 ?

Push XML Server: ?

Enable Multi Line: ?

Contact As White List Type: NONE ?

SIP Notify: Enable ?

Picture 61 - Set up an emergency call number

- 2) When the phone set the keyboard lock, you can call the emergency call number without unlocking, as shown in the figure:

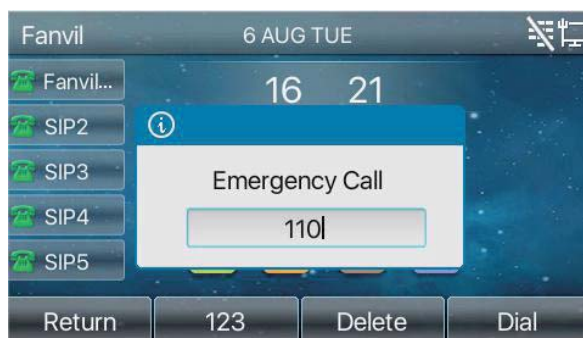

Picture 62 - Dial the emergency number

9 Advance Function

9.1 BLF (Busy Lamp Field)

9.1.1 Configure the BLF Functionality

- Page interface: log in the phone page, enter the [Function key] >> [Function key] page, select a DSS key, set the function key type as memory key, choose subtype among BLF/NEW CALL, BLF/BXFER, BLF/AXFER, BLF/CONF, set BLF/DTMF value as the number to be subscribed, set the corresponding SIP line. The pickup number is provided by the server. The specific usage refers to [8.16 Pick up](#).

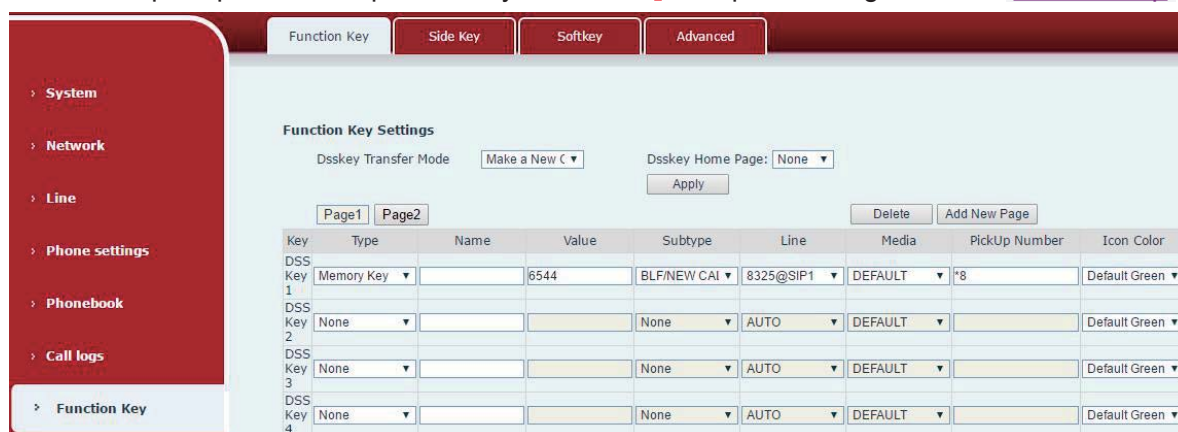

Picture 63 - Web page configuration BLF function key

- Phone interface: long press a function key to enter the function key Settings interface, or go to the [Menu] >> [Basic Settings] >> [Keyboard Settings] to enter [Soft function key] to set the settings interface, set the key function types as memory keys and a subtype of BLF/NEW CALL, BLF/BXFER, BLF/AXFER, BLF/CONF, BLF/DTMF. The values is the subscription number, and set up corresponding SIP lines.

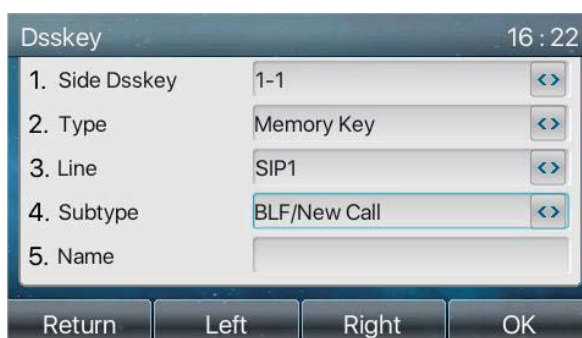

Picture 64 - Phone configuration BLF function key

Table 12 - BLF Function key subtype parameter list

Subtype	Standby is described	Calling is described
BLF/NEW CALL	Pressing the BLF key while standby to dial the subscriber number.	When you press this BLF key while talking to another user, you create a new call along with the

		subscribed number.
BLF/BXFER	Pressing the BLF key while standby to dial the subscriber number.	When you press this BLF key while talking to another user, you blind transfer the call to the subscribed number.
BLF/AXFER	Pressing the BLF key while standby to dial the subscriber number.	When you press this BLF key while talking to another user, you attendance transfer the call to the subscribed number.
BLF/Conference	Pressing the BLF key while standby to dial the subscriber number.	When you press this BLF key while talking to another user, you invite the subscriber number to join the meeting.
BLF/DTMF	Pressing the BLF key while standby to dial the subscriber number.	When the BLF key is pressed while talking to another user, the phone automatically sends the DTMF corresponding to the BLF key number.

9.1.2 Use the BLF Function

The BLF, also known as a "busy light field," notifies the user of the status of the subscribed object and is used by the server to pick up the call. BLF helps you monitor the other person's status (idle, ringing, talking, off).

BLF function:

- Monitor the status of subscribed phones.
- Call the subscribed number.
- Transfer calls/calls to the subscribed number.
- Pickup incoming calls from subscribed number.

1) Monitors the status of subscribed phones.

Configuration BLF function keys, when the subscription of the number of the state (idle, ringing, talking) is changed, the LED lights of function key will have corresponding change, see [appendix III 6.3 LED](#) to get to know each other under different status leds.

2) Call the subscribed number.

When the phone is in standby mode, press the configured BLF key to call out the subscribed number.

3) Transfer calls to the subscribed number.

Refer to [Table 9.1.1-blif function key](#) subtype parameter list, the BLF key can be used for blind rotation, attention-rotation and semi-attention-rotation of the current call, and also can invite the subscribed number to join the call and send DTMF, etc.

4) Pickup incoming calls from subscribed phones.

When configuring BLF function key, configure the pickup number.

When the subscription number telephone rings, refer to [appendix III 6.3, BLF LED](#) will turn red at this time. At this point, press the BLF button to answer the incoming call from the subscribed number.

9.2 BLF List

BLF List Key is to put the number to be subscribed into a group on the server side, and the phone uses the URL of this group to make unified subscription. The specific information, number, name and status of each number can be resolved based on notify sent from the server. The unoccupied Memory Key is then set as the BLF List Key. If the state of the subscription object changes later, the corresponding led light state will be changed.

Configure BLF List function: log in the phone page, enter the [Line] >> [SIP] >> [Advanced settings] page, open the BLF List, and configure the BLF List number.

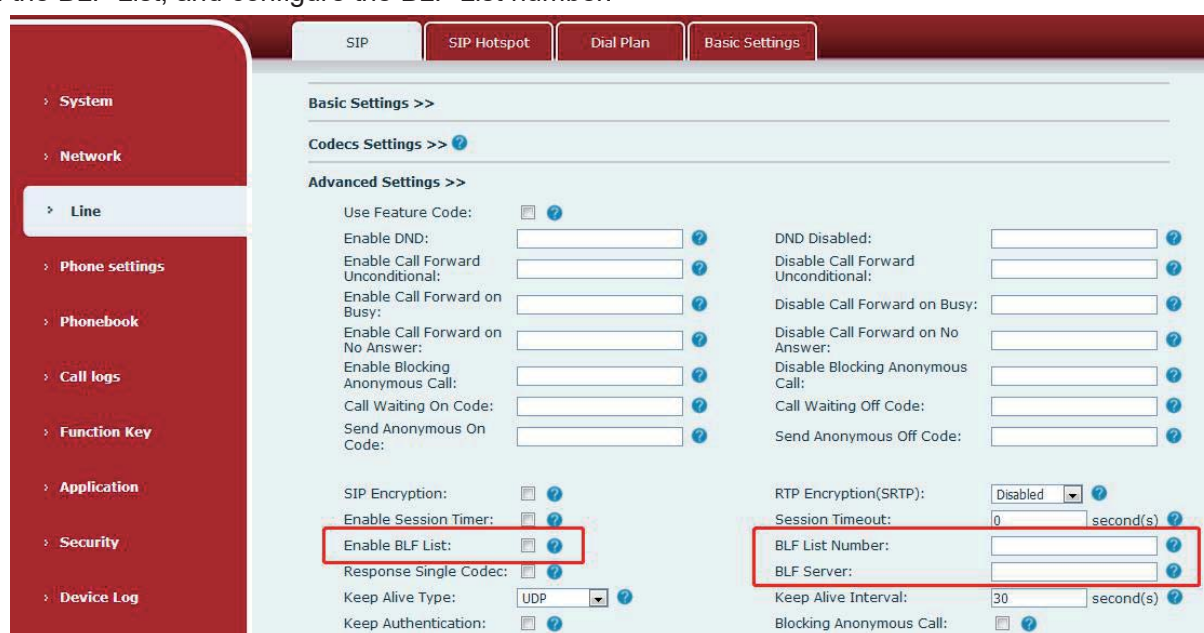

Picture 65 - Configure the BLF List functionality

Use the BLF List function: when the configuration is completed, the phone will automatically subscribe to the contents of the BLF List group. Users can monitor, call and transfer the corresponding number by pressing the BLF List key.

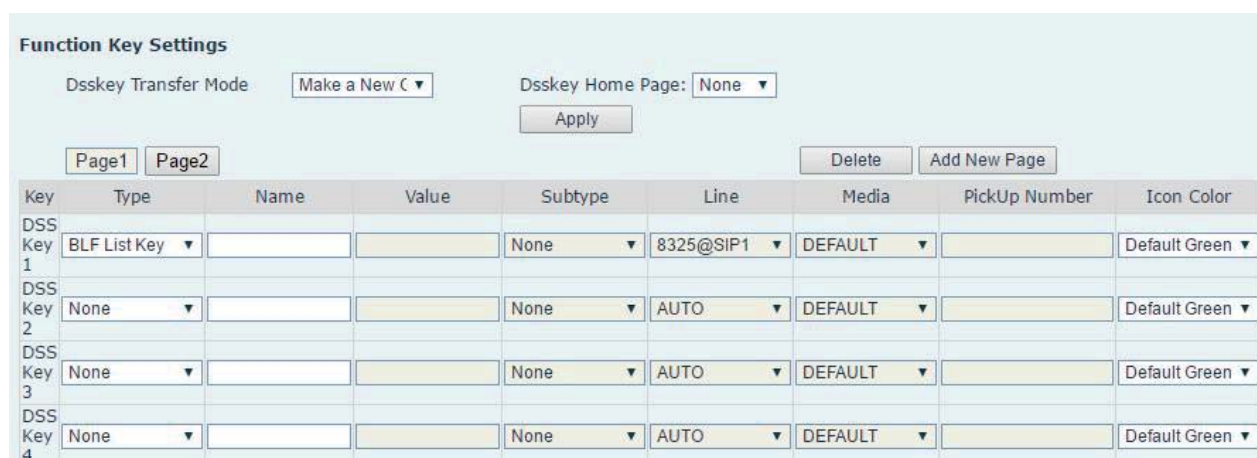

Picture 66 - BLF List number display

9.3 Record

The device supports recording during a call.

9.3.1 Local Record (USB flash disk)

The local recording must be mounted on a usb flash drive to support recording, so the device needs to support a usb flash drive. Please refer to [4.2 hardware description](#) for the supported model.

When using local recording, it is necessary to start recording on the phone page

[**Application**] >> [**Manage recording**], select the local type and set the voice coding.

The webpage is as follows:

Record Setting

Enable Record:

Record Type: Local

Voice Codec: G729

Apply

Recording List

Index	File Name	File Size
Delete		

Picture 67 - Local Record

Local recording steps:

- Plug the U disk into the USB port of the phone, open the recording on the web page, and set the recording type as local recording.
- Set DSSkey type as key event and type as record in the phone/web interface.
- Set up one line call and press the recording key (set DSSkey).
- End the recording. End the call.

View local recording:

- Enter [**Menu**] >> [**Application**] >> [**USB**].
- Enter [**USB**] to view the recording file.
- Or enter the webpage [**Application**] under the [**Manage recording**] to view the recording file.

Listen to the record:

- Enter [**Menu**] >> [**Application**] >> [**USB**].
- Enter [**USB**] to view the recording file.
- Select the recording file that you want to listen to, and click the "play" button of Soft key to listen to the recording.

9.3.2 Server Record

When using the network server to record, it is necessary to open the recording in the phone web page [**Application**] >> [**Manage recording**]. The type is selected as network, and the address and port of the recording server are filled in and the voice coding is selected. The web is as follows:

Record Setting

Enable Record:

Record Type: Network

Voice Codec: PCMU

Server Address: Server Port:

Recording List

Index	File Name	File Size
<input type="button" value="Delete"/>		

Picture 66 - Web server recording

Note: to be used with Fanvil recording software.

9.3.3 SIP INFO Record

The phone is registered with a server that supports SIP INFO recording. After registering the account, check the recording module of **[Application]** >> **[Manage recording]** to open the recording, and the recording type is SIP INFO.

Record Setting

Enable Record:

Record Type: Sip Info

Recording List

Index	File Name	File Size
<input type="button" value="Delete"/>		

Picture 69 - Web SIP info recording

9.4 Agent

Agent (Agent function) of the phone can be realized: when multiple people use a device for Agent services at different times, he or she can quickly register his or her SIP account on the same server. The Agent functions of the phone can be divided into Normal and Hotel Guest. The Hotel Guest mode requires server support.

Normal Mode:

Configure agent function: set a DSSkey as agent, press the function key or enter the **[Menu]** >>

[Features] >> **[Agent]** to enter the agent page. The SIP server needs to be configured before the account can be configured.

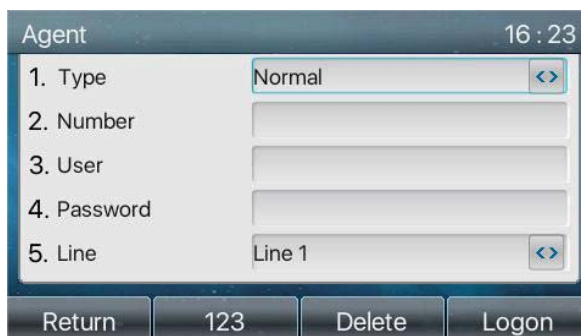

Picture 70 - Configure the agent account in normal mode

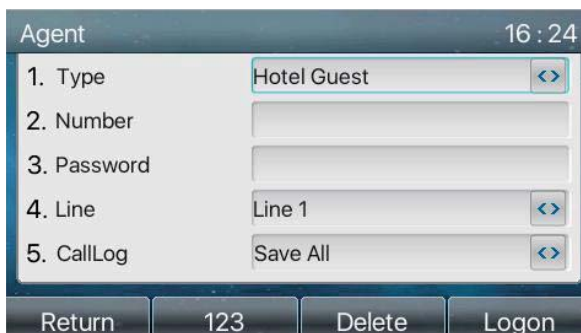

Picture 71 - Configure the proxy account-hotel Guest mode

Table 13 - Agency mode

Parameter	Description
Normal mode	
Number	Set the proxy account number.
User	Set the proxy account number to verify the user name.
Password	Set the proxy account number to verify the password.
Line	Select the SIP line.
CallLog	Users can choose to save all types, or delete.
Hotel Guest mode	
Number	Set the proxy account number.
Password	Set the proxy account number to verify the password.
Line	Select the SIP line.
CallLog	Users can choose to save all types, or delete.

Using agent functions:

- 1) When the phone has been configured on SIP server, fill in the correct number and user name password, click login and then the phone can be registered to the SIP server;
- 2) After registration, click logout and the phone can delete the user name and password, and log out of the SIP account.
- 3) Click Unregister and the phone retains the user name and password, and logs out of the SIP account.

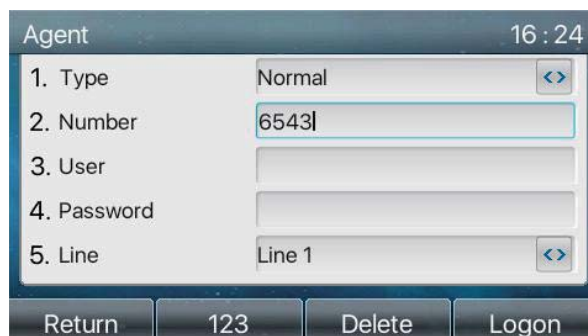

Picture 72 - Agent logon page

9.5 Intercom

When the Intercom is enabled, it can automatically receive calls from the intercom.

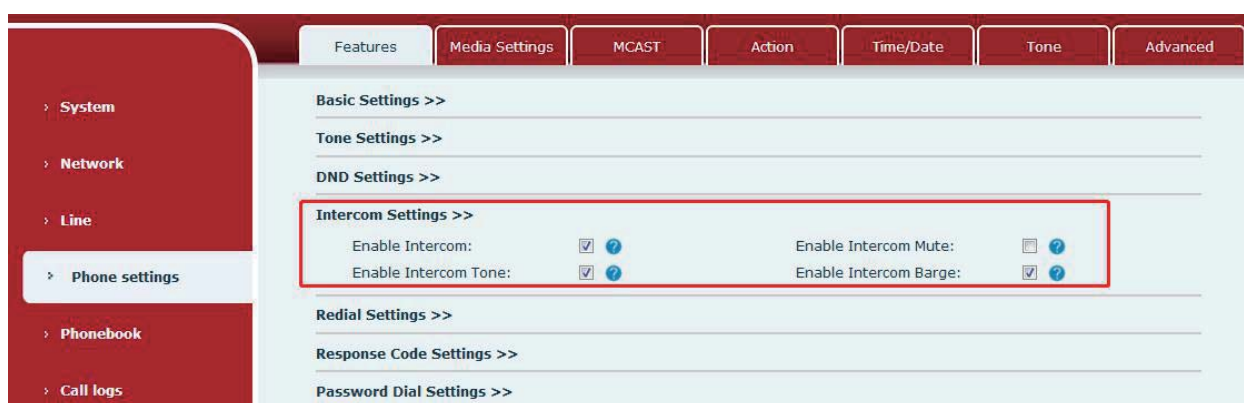

Picture 73 - Web Intercom configure

Table 14 - Intercom configure

Parameter	Description
Enable Intercom	When intercom is enabled, the device will accept the incoming call request with a SIP header of Alert-Info instruction to automatically answer the call after specific delay.
Enable Intercom Mute	Enable mute mode during the intercom call
Enable Intercom Tone	If the incoming call is intercom call, the phone plays the intercom tone
Enable Intercom Barge	Enable Intercom Barge by selecting it, the phone auto answers the intercom call during a call. If the current call is intercom call, the phone will reject the second intercom call

9.6 MCAST

This feature allows user to make some kind of broadcast call to people who are in multicast group. User can

configure a multicast DSS Key on the phone, which allows user to send a Real Time Transport Protocol (RTP) stream to the pre-configured multicast address without involving SIP signaling. You can also configure the phone to receive an RTP stream from pre-configured multicast listening address without involving SIP signaling. You can specify up to 10 multicast listening addresses.

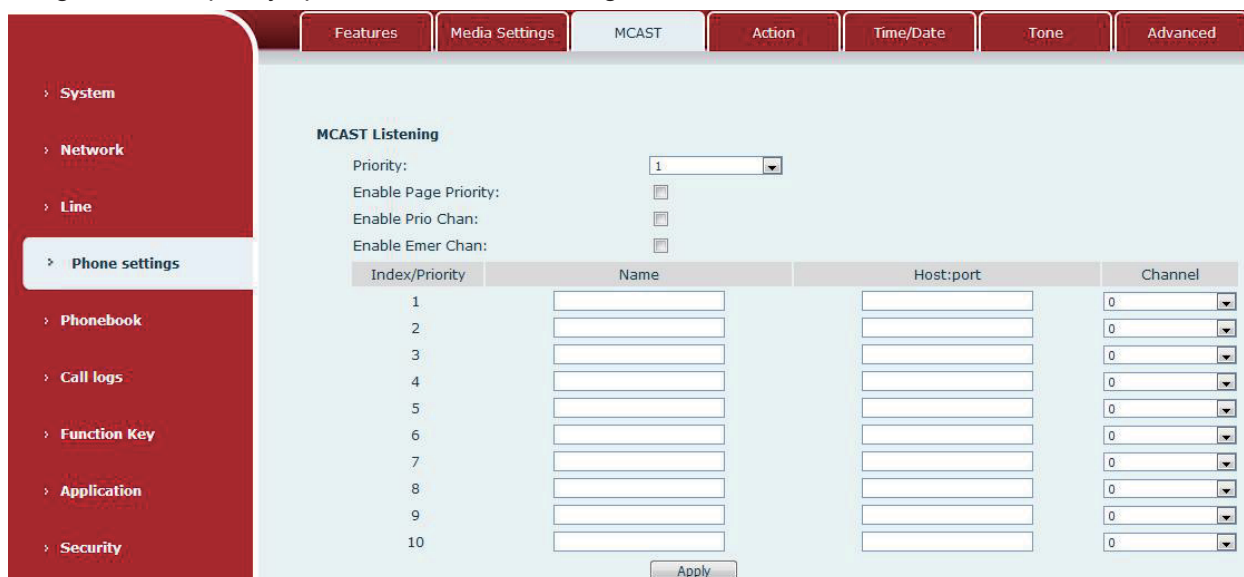

Picture 74 - Multicast Settings Page

Table 15 - MCAST Parameters on Web

Parameters	Description
Normal Call Priority	Define the priority of the active call, 1 is the highest priority, 10 is the lowest.
Enable Page Priority	The voice call in progress shall take precedence over all incoming paging calls.
Name	Listened multicast server name
Host:port	Listened multicast server's multicast IP address and port.

Multicast:

- Go to web page of [Function Key] >> [Function Key] , select the type to multicast, set the multicast address, and select the codec.
- Click Apply.
- Set up the name, host and port of the receiving multicast on the web page of [Phone Settings] >> [MCAST].
- Press the DSSKY of Multicast Key which you set.
- Receive end will receive multicast call and play multicast automatically.

9.7 SCA (Shared Call Appearance)

Users need the support of server end to use SCA function. You can refer to <http://www.fanvil.com/Uploads/Temp/download/20180920/5ba38181e4e4b.pdf>

- 1) Configure on Phone

- When registering with the BroadSoft server, a Fanvil Phone can register the account created previously on multiple terminals.

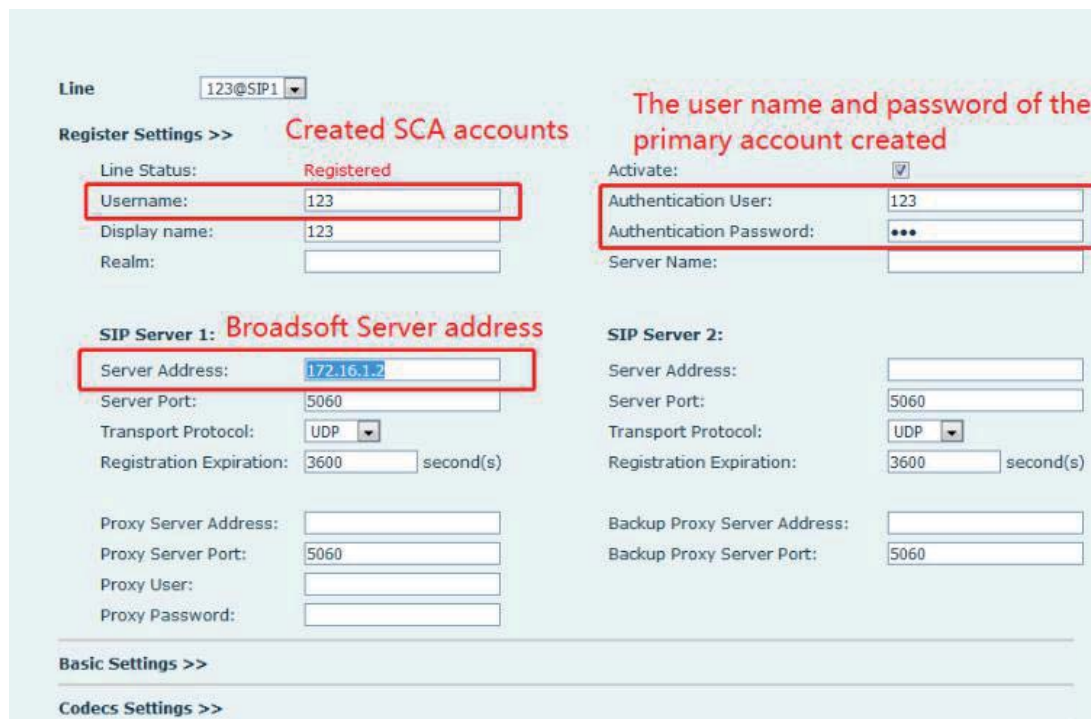

Picture 75 - Register BroadSoft account

- After the phone set registers with the BroadSoft server, a server type needs to be set. Specifically, log in to the webpage of the phone set, choose [Line] >> [SIP] >> [Advanced Settings] and set Specific Server Type to BroadSoft, as shown in the following figure.

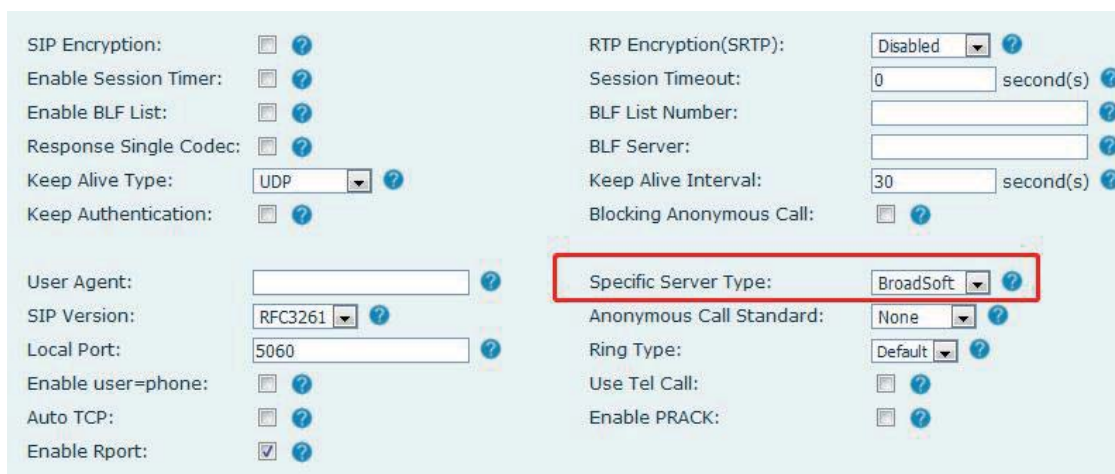

Picture 76 - Set BroadSoft server

- If a Fanvil phone needs to enable the SCA function. Specifically, log in to the webpage of the phone set, choose [Line] >> [SIP] >> [Advanced Settings], and select Enable SCA. If SCA is not enabled, the registered line is the private line.

DNS Mode: A
 Enable Strict Proxy:
 Use Quote in Display Name:
 Sync Clock Time:
 Caller ID Header: PAI-RPID-Ff
 Enable Feature Sync:
 CallPark Number:
 TLS Version: TLS 1.0
 Enable Click To Talk:
 Flash Mode: Normal
 Flash Info Content-Body:
 JoinCall Number:
 Unregister On Boot:
 Enable Register MAC Header:
 PTime(ms): Disabled
 Session Timer T1: 500 (500~10000)millisecond
 Session Timer T4: 5000 (2500~60000)millisecond
 Enable Long Contact:
 Convert URI:
 Enable GRUU:
 Enable Use Inactive Hold:
 Use 182 Response for Call waiting:
Enable SCA:
 Server Expire:
 uaCSTA Number:
 Enable ChangePort:
 Flash Info Content-Type:
 Pickup Number:
 Intercom Number:
 Enable MAC Header:
 BLF Dialog Strict Match:
 Enable Deal 180:
 Session Timer T2: 4000 (2000~40000)millisecond

Picture 75 - Enable SCA

After an account is configured and successfully registered, you can configure lines whose DSS Key is Shared Call Appearance on the Function Key page to facilitate viewing the call status of the group. Each line key represents a call appearance. Understand the call status by referring to [6.3 Appendix III –LED](#). To facilitate private hold, configure keys whose DSS Key is Private Hold on the Function Key page. Pay attention that the public hold key is the softkey-hold key during a call.

Function Key Settings

Dsskey Transfer Mode: Dsskey Home Page:

Key	Type	Name	Value	Subtype	Line	Media	PickUp Number	Icon Color
DSS Key 1	Key Event			Private Hold	8325@SIP1	DEFAULT		Default Green
DSS Key 2	None			None	AUTO	DEFAULT		Default Green
DSS Key 3	None			None	AUTO	DEFAULT		Default Green
DSS Key 4	None			None	AUTO	DEFAULT		Default Green

Picture 76 - Set Private Hold Function Key

- Each phone registered with the BroadSoft server should be configured as above, then the SCA function can be used.

2) LED Status

To facilitate viewing the call status of a group, configure the DSS Key as SCA. The following table describes

the LEDs of lines in different states.

Table 16 - LED Status of SCA

State&Direction	Local	Remote
Idle	Off	Off
Seized	Steady green	Steady red
Progressing (outgoing call)	Steady green	Steady red
Alerting (incoming call)	Fast blinking green	Fast blinking green
Active	Steady green	Steady red
Public Held (hold)	Slow blinking green	Slow blinking red
Held-private (private hold)	Slow blinking yellow	Steady red
Bridge-active (Barge-in)	Steady green	Steady red
Bridge-held	Steady green	Steady red

3) Shared Call Appearance(SCA)

The following lists a couple of instances to facilitate understanding.

In the following scenarios, the manager and secretary register the same SCA account and the account is configured based on the preceding steps.

Scenario 1: When this account receives an incoming call, the phone sets of both the manager and the secretary will receive the call and ring. If the manager is busy, the manager can reject the call and the manager's phone set stops ringing but the secretary's phone set keeps ringing until the secretary rejects/answers the call or the call times out.

Scenario 2: When this account receives an incoming call, if the secretary answers the call first and the manager is required to answer the call, the secretary can press the Public Hold key to hold this call and notify the manager. The manager can press the line key corresponding to the SCA to answer the call.

Scenario 3: The manager is in an important call with a customer and needs to leave for a while. If the manager does not want others to retrieve this call, the manager can press the Private Hold key.

Scenario 4: The manager is in a call with a customer and requires the secretary to join the call to make records. The secretary can press the corresponding SCA line key to barge in this call.

9.8 Message

9.8.1 SMS

If the service of the line supports the function of the short message, when the other end sends a text message to the number, the user will receive the notification of the short message and display the icon of the new SMS on the standby screen interface.

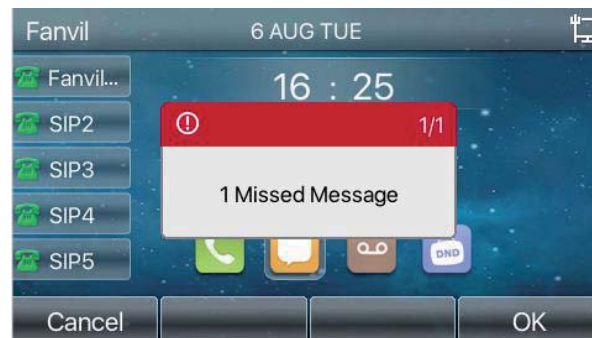

Picture 79 - SMS icon

Send messages:

- Go to [Menu] >> [Message] >> [SMS].
- Users can create new messages, select lines and send numbers.
- After editing is completed, click Send.

View SMS:

- Use the navigation keys to select the standby icon [message]
- After selecting, press the navigation key [OK] to enter the SMS inbox interface.
- Select the unread message and press [OK] to read the unread message.

Reply to SMS:

- Use the navigation keys to select the standby icon [Message].
- After selecting, press the navigation key [OK] to enter the SMS inbox interface.
- Select the message you want to reply to, select Softkey's [Reply], edit it, and click Send.

9.8.2 MWI (Message Waiting Indicator)

If the service of the lines supports voice message feature, when the user is not available to answer the call, the caller can leave a voice message on the server to the user. User will receive voice message notification from the server and device will prompt a voice message waiting icon on the standby screen.

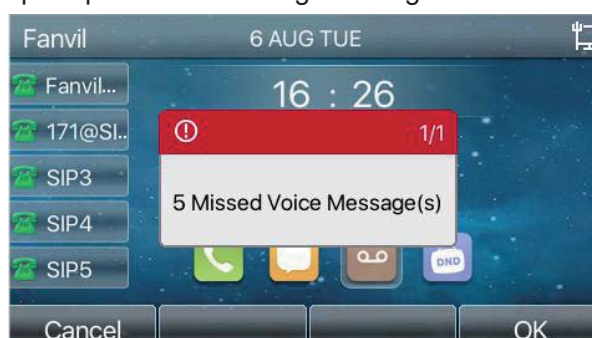

Picture 80 - New Voice Message Notification

Voice message icon

To listen to a voice message, the user must first configure the voicemail number. After the voicemail number is configured, the user can retrieve the voicemail of the default line.

When the phone is in the default standby state,

- The Side Key is pre-installed with a voice message shortcut key - [MWI] key.

- Press **[MWI]** to open the voice message configuration interface, and select the line to be configured by pressing the up/down navigation buttons.
- Press the **[Edit]** button to edit the voice message number. When finished, press the **[OK]** button to save the configuration.
- In the following picture, “17” in front of Fanvil line brackets represents unread voice messages, and “17” represents the total number of voice messages.



Picture 81 - Voice message interface

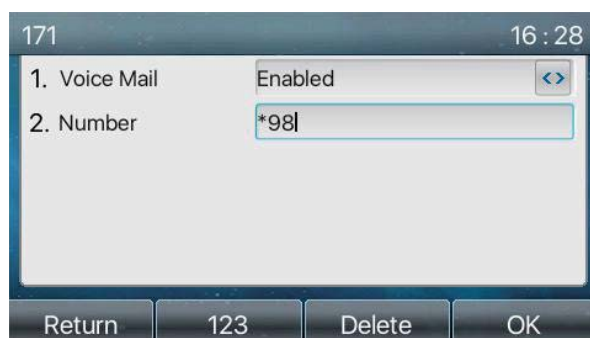

Picture 82 - Configure voicemail number

9.9 SIP Hotspot

SIP hotspot is a simple but practical function. With simple configurations, the SIP hotspot function can implement group ringing. SIP accounts can be expanded.

The users can set functions as a SIP hotspot and other phones set (B and C) function as SIP hotspot clients. When somebody calls phone set A, phone sets A, B, and C all ring at the same time. When any phone set answers the call, other phone sets stop ringing. The call can be answered by only one phone set. When B or C initiates a call, the SIP number registered by phone set A is the calling number.

To set a SIP hotspot, register at least one SIP account.

Line 258@SIP1

Register Settings >>

Line Status: **Registered**

Activate: ?

Username: ?

Authentication User: ?

Display name: ?

Authentication Password: ?

Realm: ?

Server Name: ?

SIP Server 1:

Server Address: ?

Server Port: ?

Transport Protocol: ?

Registration Expiration: second(s) ?

SIP Server 2:

Server Address: ?

Server Port: ?

Transport Protocol: ?

Registration Expiration: second(s) ?

Proxy Server Address: ?

Backup Proxy Server Address: ?

Proxy Server Port: ?

Backup Proxy Server Port: ?

Proxy User: ?

Proxy Password: ?

Picture 83 - Register SIP account

Table 17 - SIP hotspot Parameters

Parameters	Description
Device Table	If your phone is set to "SIP hotspot server", Device Table will display as Client Device Table which connected to your phone. If your phone is set to "SIP hotspot client", Device Table will display as Server Device Table which you can connect to.
SIP hotspot	
Enable hotspot	Set it to be Enable to enable the feature.
Mode	Choose hotspot, phone will be a "SIP hotspot server"; Choose Client, phone will be a "SIP hotspot Client"
Monitor Type	Either the Multicast or Broadcast is ok. If you want to limit the broadcast packets, you'd better use broadcast. But, if client choose broadcast, the SIP hotspot phone must be broadcast.
Monitor Address	The address of broadcast, hotspot server and hotspot client must be same.
Remote Port	Type the Remote port number.

Configure SIP hotspot server:

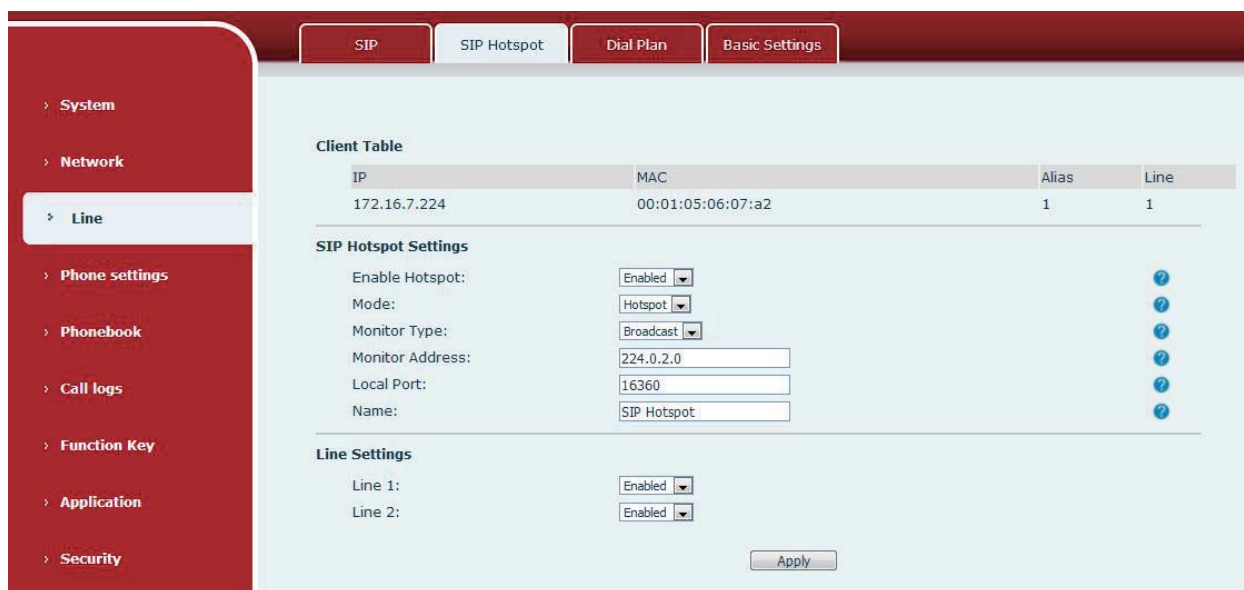

Picture 84 - SIP hotspot server configuration

Configure SIP hotspot client:

To set as a SIP hotspot client, no SIP account needs to be set. The Phone set will automatically obtain and configure a SIP account. On the SIP Hotspot tab page, set Mode to Client. The values of other options are the same as those of the hotspot.

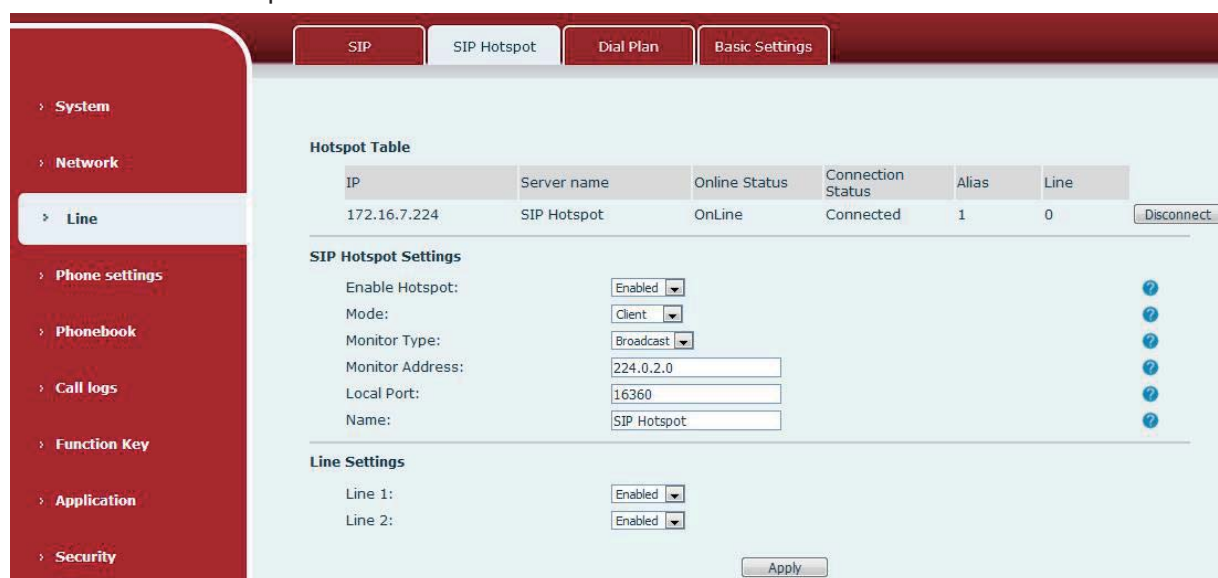

Picture 85 - SIP hotspot client configuration

As the hotspot server, the default extension number is 0. When the phone is used as the client, the extension number is increased from 1, you can view the extension number through the [SIP Hotspot] page.

Call extension number:

- The hotspot server and the client can dial each other through the extension number.
- For example, extension 1 dials extension 0.

10 Phone Settings

10.1 Basic Settings

10.1.1 Language

The user can set the phone language through the phone interface and web interface.

- Phone end: After resetting the factory settings, the user needs to set the language; when setting the language during standby, go to **[Menu] >> [Basic] >> [Language]** Settings, as shown in the figure.



Picture 86 - Phone language setting

- Web interface: Log in to the phone webpage and set the language in the drop-down box at the top right corner of the page, as shown in the figure:

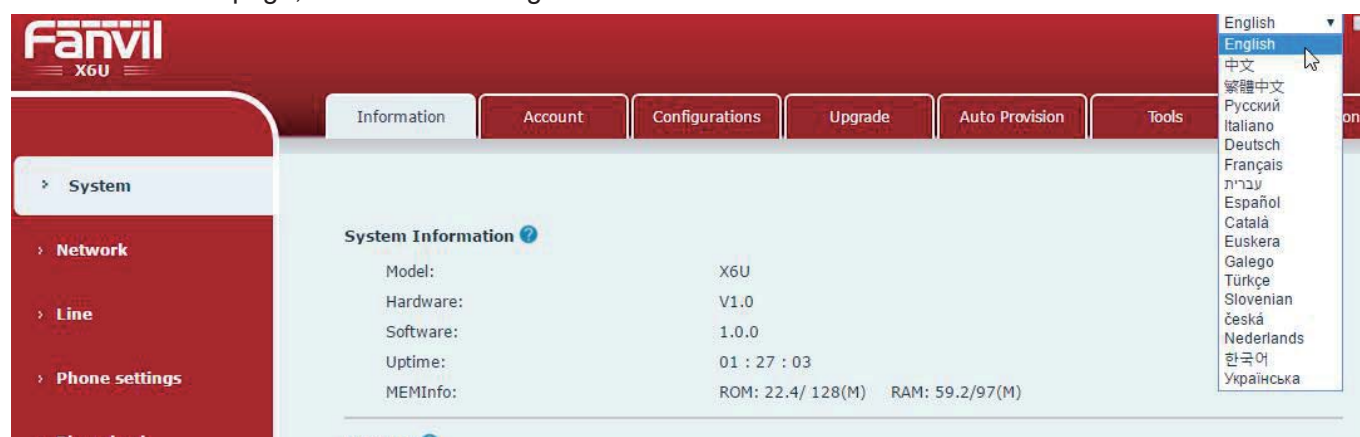

Picture 87 - Language setting on Web page

- The function box on the right side of the web interface language setting box is “Synchronize language to phone”; if selected, the phone language will be synchronized with the webpage language. If it is not selected, it will not be synchronized.

10.1.2 Time & Date

Users can set the phone time through the phone interface and web interface.

- Phone end: When the phone is in the default standby state, press the **[Menu] >> [Basic] >> [Time & Date]**, use the up/down navigation button to edit parameters, press the **[OK]** to save after completion, as shown in the figure:



Picture 88 - Set time & date on phone

- Web end: Log in to the phone webpage and enter [Phone Settings] >> [Time/Date] , as shown in the figure:

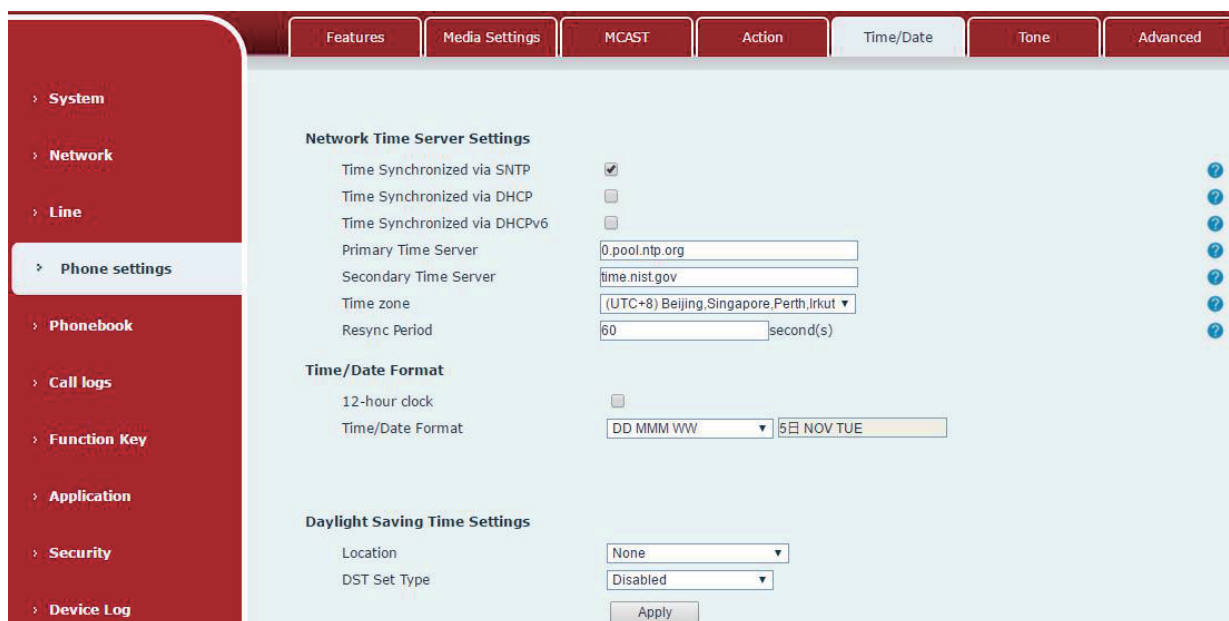

Picture 89 - Set time & date on webpage

Table 18 - Time Settings Parameters

Parameters	Description
Mode	Auto/Manual Auto: Enable network time synchronization via SNTP protocol, default enabled. Manual: User can modify data manually.
SNTP Server	SNTP server address
Time zone	Select the time zone
Time format	Select time format from one of the followings: <ul style="list-style-type: none"> ■ 1 JAN, MON ■ 1 January, Monday ■ JAN 1, MON ■ January 1, Monday

	<ul style="list-style-type: none"> ■ MON, 1 JAN ■ Monday, 1 January ■ MON, JAN 1 ■ Monday, January 1 ■ DD-MM-YY ■ DD-MM-YYYY ■ MM-DD-YY ■ MM-DD-YYYY ■ YY-MM-DD ■ YYYY-MM-DD
Separator	Choose the separator between year and moth and day
12-Hour Clock	Display the clock in 12-hour format
Daylight Saving Time	Enable or Disable the Daylight Saving Time

10.1.3 Screen

The user can set the phone screen parameters through both of the phone interface and web interface.

- Phone: When the phone is in the default standby state, go to **[Menu]** >> **[Basic]** >> **[Screen Settings]** to edit the screen parameters. After editing, click **[OK]** to save, as shown in the figure:



Picture 90 - Set screen parameters on phone

- Web : Go to **[Phone Settings]** >> **[Advanced]** Advanced, edit the screen parameters, and click Apply to save.

10.1.3.1 Brightness and backlight

- Set the brightness level in use from 1 to 16, [**<**] or [**>**] switch brightness level.
- Set the brightness level in the energy-saving mode from 0 to 16, [**<**] or [**>**] switch the brightness level.
- Set the backlight time to 30 seconds by default. You can turn it off or select 15 seconds /30 seconds /45 seconds /60 seconds /90 seconds /120 seconds.
- The screen saver can be turned on or off by default.
- Web interface: enter **[Phone Settings]** >> **[Advanced]**, edit screen parameters, and click submit to save.

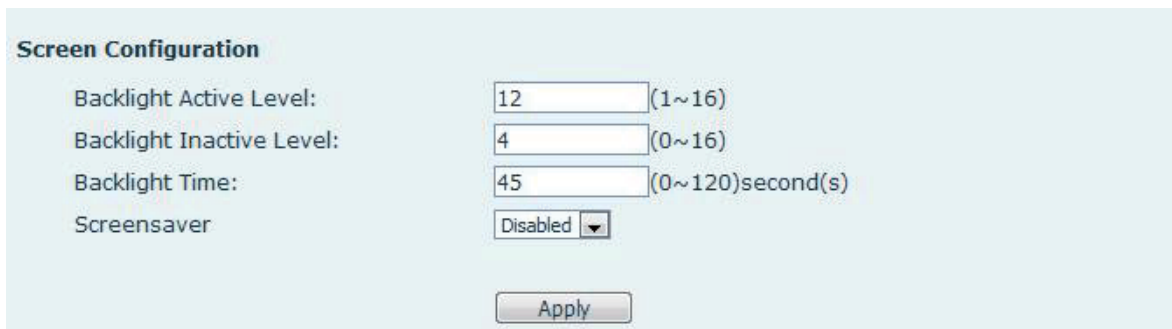

Picture 91 - Page screen Settings

10.1.3.2 Screen Saver

- Press [**Screen Settings**] to find the [**Screen protection**] button, press [**left**] / [**right**] button to open/close the screen protection, set the timeout time, the default is 15S, after completion, press [**OK**] button to save.
- After saving, return to standby mode and enter the screen saver after 15s, as follows:



Picture 92 - Phone screen saver

10.1.4 Ring

When the device is in the default standby mode,

- Press soft-button [**Menu**] till you find the [**Basic**] item.
- Enter [**Basic**] item till you find [**Ring**] item.
- Enter [**Ring**] item and you will find [**Headset**] or [**Handsfree**] item, press left / right navigator keys to adjust the ring volume, save the adjustment by pressing [**OK**] when done.
- Enter [**Ring type**] item, press left / right navigator keys to change the ring type, save the adjustment by pressing [**OK**] when done.

10.1.5 Voice Volume

When the device is in the default standby mode,

- Press soft-button [**Menu**] till you find the [**Basic**] item.
- Enter [**Basic**] item till you find [**Voice Volume**] item.
- Enter [**Voice Volume**] item and you will find [**Headset**], [**Handsfree**] and [**Headset**] item.
- Enter [**Headset**] or [**Handsfree**] or [**Headset**] item, press Left / Right navigator keys to adjust the audio volume for different mode.
- Save the adjustment by pressing [**OK**] when done.

10.1.6 Greeting Words

When the device is in the default standby mode,

- Press soft-button **[Menu]** till you find the **[Basic]** item.
- Enter **[Basic]** item till you find **[Greeting Words]** item.
- Press **[OK]** to enter the setting interface to edit the Greetings Words.
- Save the adjustment by pressing **[OK]** when done.

NOTICE! The welcome message can only be displayed in the upper left corner of standby mode when the default option is disabled.

10.1.7 Reboot

When the device is in the default standby mode,

- Press soft-button **[Menu]** till you find the **[Basic]** item.
- Enter **[Basic]** item till you find **[Reboot]** item.
- Press **[OK]** a prompt message, "restart now," prompts the user.
- Press **[OK]** to restart the phone or **[Cancel]**.

The phone is in standby mode,

- The configurable **[OK]** key is the restart key. Press **[OK]**, a prompt message, "restart now" prompts the user.
- Press **[OK]** to restart the phone or **[Cancel]** to exit.

10.2 Phone Book

10.2.1 Local Contact

User can save contacts' information in the phone book and dial the contact's phone number(s) from the phone book. To open the phone book, user should press soft-menu button **[Contact]** in the default standby screen or keypad.

By default the phone book is empty, user may add contact(s) into the phone book manually or from call logs.



Picture 93 - Phone book screen

Note! Phone user account can store contact information, different models and specifications.

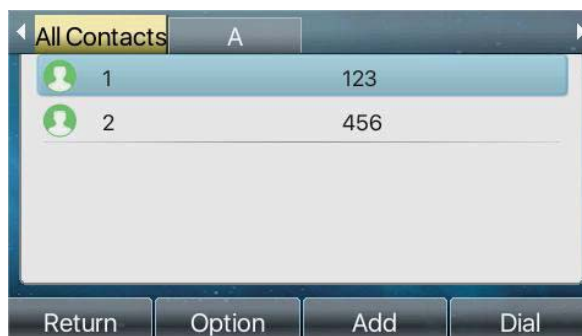

Picture 94 - Local Phone book

When there are contact records in the phone book, the contact records will be arranged in the alphabet order. User may browse the contacts with up/down navigator keys. The record indicator tells user which contact is currently focused. User may check the contact's information by pressing [OK] button.

10.2.1.1 Add / Edit / Delete Contact

To add a new contact, user should press [Add] button to open Add Contact screen and enter the contact information of the followings,

- Contact Name
- Tel. Number
- Mobile Number
- Other Number
- Line
- Ring Tone
- Contact Group
- Photo

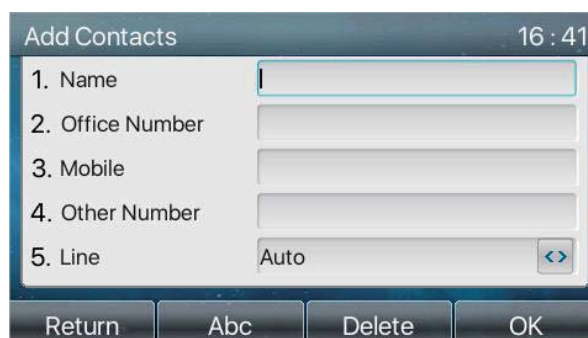

Picture 95 - Add New Contact

User can edit a contact by pressing [Option] >> [Edit] button.

To delete a contact, user should move the record indicator to the position of the contact to be deleted, press [Option] >> [Delete] button and confirm with [OK].

10.2.1.2 Add / Edit / Delete Group

By default, the group list is blank. User can create his/her own groups, edit the group name, add or remove

contacts in the group, and delete a group.

- To add a group, press **[Add Group]** button.
- To delete a group, press **[Option]** >> **[Delete]** button.
- To edit a group, press **[Edit]** button.
- The Number behind the group name means the total contacts number of selected groups.

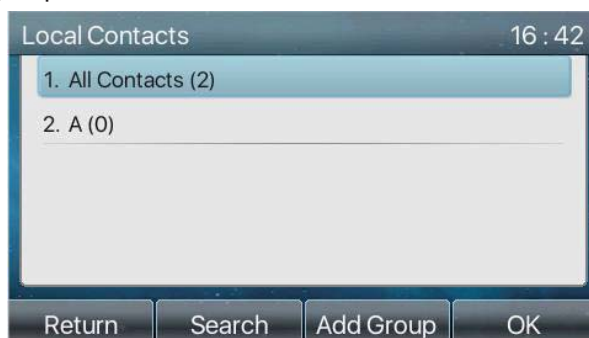

Picture 96 - Group List

10.2.1.3 Browse and Add / Remove Contacts in Group

User can browse contacts in a group by opening the group in group list with **[OK]** button.



Picture 97 - Browsing Contacts in a Group

When user is browsing contacts of a group, user can also add contacts in that group by pressing **[Add]** button to enter the group contacts management interface, then press **[OK]** button to save the contact. The contact will also be added in local phonebook. User can delete contact from group by **[Option]** >> **[Delete]**.



Picture 98 - Add Contacts in a Group

10.2.2 Blacklist

The device Support blacklist, such as the number added to the blacklist, the number of calls directly refused

to the end, the end of the phone shows no incoming calls. (Blacklisted Numbers can be called out normally)

- There are multiple ways to add a number to Blacklist on X210 device. It can be added directly on **[Menu] >> [Contact] >> [Blacklist]**.
- Select any number in the phone book (both local and network) for configuration addition.
- Select any number in the call log for configuration addition.

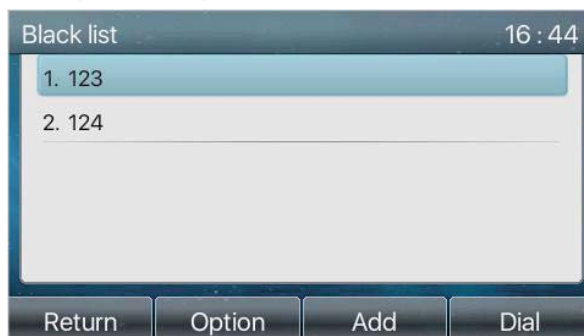

Picture 99 - Add Blacklist

- There are various ways to add number to the blacklist on web page, which can be added in the **[Phone book] >> [Call list] >> [Restricted Incoming Calls]**.
- Select any number in the phone book (both local and network) for configuration addition.
- Select any number in the call log for configuration addition.

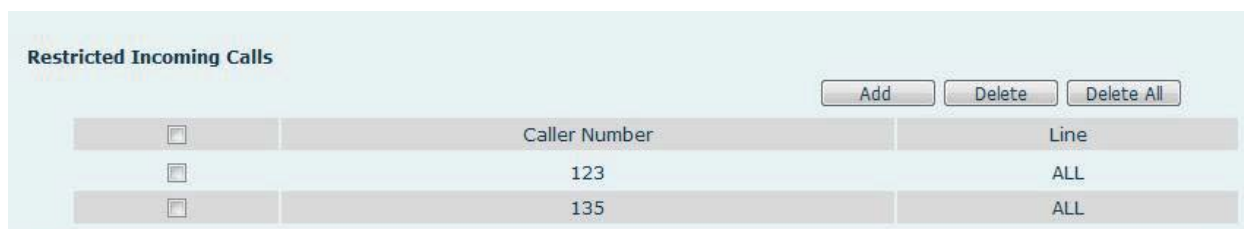

Picture 100 - Web Blacklist

10.2.3 Cloud Phone Book

10.2.3.1 Configure Cloud Phone book

Cloud phonebook allows user to configure the device by downloading a phonebook from a cloud server. This is convenient for office users to use the phonebook from a single source and save the effort to create and maintain the contact list individually. It is also a useful tool to synchronize his/her phonebook from a personal mobile phone to the device with Fanvil Cloud Phonebook Service and App which is to be provided publicly soon.

NOTICE! The cloud phonebook is **ONLY temporarily downloaded to the device each time when it is opened on the device to ensure the user get the latest phonebook. However, the downloading may take a couple seconds depending on the network condition. Therefore, it is highly recommended for the users to save important contacts from cloud to local phonebook for saving download time.**

Open cloud phonebook list, press **[Menu] >> [PhoneBook] >> [Cloud Contacts]** in phonebook screen.

TIPS! The first configuration on cloud phone should be completed on Web page by selecting **[PhoneBook] >> [Cloud Contacts]**. The setting of addition/deletion on device could be done after the

first setting on Web page.

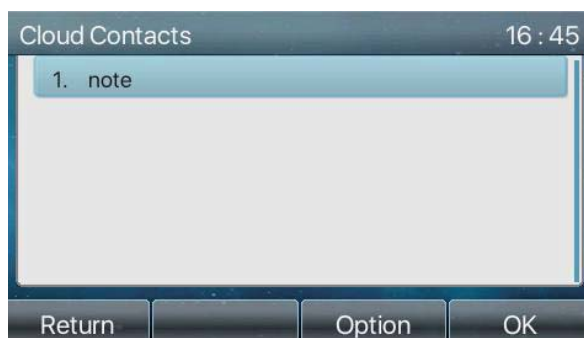

Picture 101 - Cloud phone book list

10.2.3.2 Downloading Cloud Phone book

In cloud phone book screen, user can open a cloud phone book by pressing [OK] / [Enter] button. The device will start downloading the phone book. The user will be prompted with a warning message if the download fails,

Once the cloud phone book is downloaded completely, the user can browse the contact list and dial the contact number same as in local phonebook.

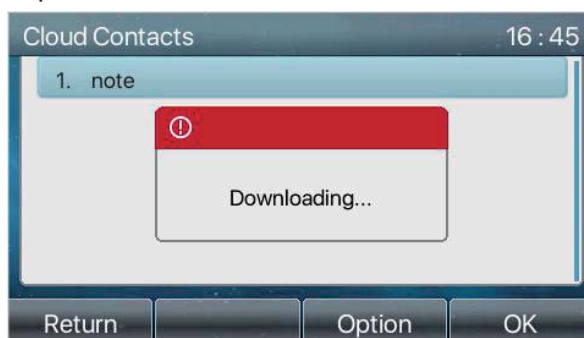

Picture 102 - Downloading Cloud Phone book

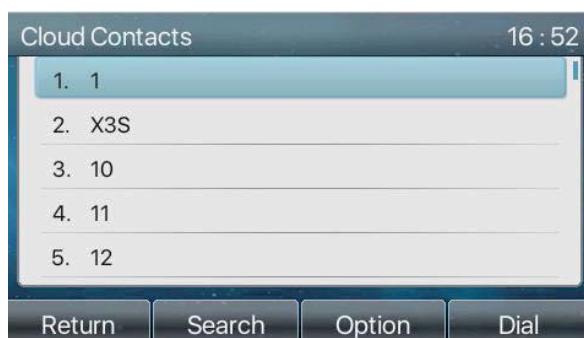

Picture 103 - Browsing Contacts in Cloud Phone book

10.3 Call Log

The phone can store the call record (the quantity of storage varies according to different specifications). The user can press [CallLog] to open the call record and check the records of all incoming calls, outgoing calls and missed calls.

In the call logs interface, user may browse the call logs with up/down navigator keys.

Each call log record is presented with 'call type' and 'call party number / name'. User can check further call log detail by pressing [OK] button and dial the number with [Dial] button, or add the call log number to phonebook with pressing [Option] >> [Add to Contact] .

User can delete a call log by pressing [Delete] button and clear all call logs by pressing [Delete All] button.

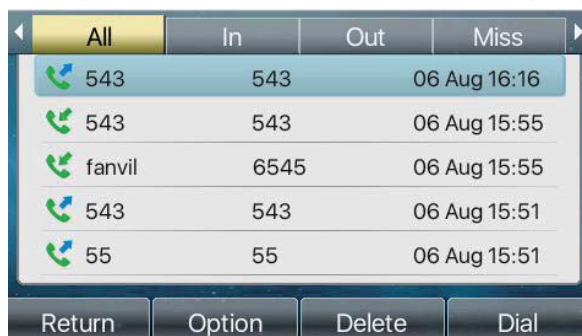

Picture 104 - Call Log

Users can also filter the call records of specific call types to narrow down the scope of search records, and select a call record type by left and right navigation keys.

- Missed Call Log
- Incoming Call Log
- Outgoing Call Log
- Forward Call Log



Picture 105 - Filter call record types

10.4 Function Key

Users can use the page switch key to switch DSS display pages quickly. In addition, the user can also long press each DSS key to modify the corresponding key Settings.

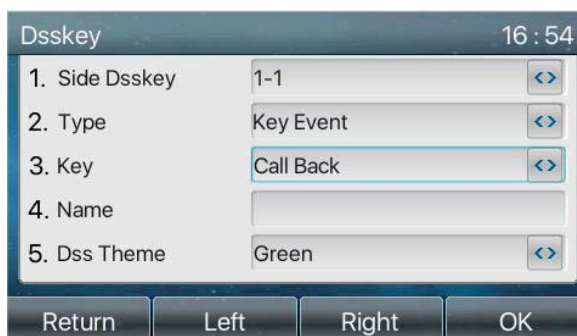

Picture 106 - DSS LCD key Page Configuration Screen

The DSS Key could be configured as followings,

- ◆ Memory Key
 - Speed Dial/Intercom/BLF/Presence/Call Park/Call Forward (to someone)
- ◆ Line
- ◆ Key Event
 - MWI/DND/Hold/Transfer/Phonebook/Redial/Pickup/Call Forward (to specified line)/Headset/SMS/Release
- ◆ DTMF
- ◆ Action URL
- ◆ BLF List Key
- ◆ Multicast
- ◆ Action URL
- ◆ XML Browser

Webpage interface: [Function key] >> [Function key].

Function Key Settings									
Dsskey Transfer Mode		Make a New C ▾		Dsskey Home Page: None ▾					
					Apply				
Page1		Page2		Delete		Add New Page			
Key	Type	Name	Value	Subtype	Line	Media	PickUp Number	Icon Color	
DSS Key 1	Line ▾			None ▾	8325@SIP1 ▾	DEFAULT ▾		Default Green ▾	
DSS Key 2	Line ▾			None ▾	SIP2 ▾	DEFAULT ▾		Default Green ▾	
DSS Key 3	None ▾			None ▾	AUTO ▾	DEFAULT ▾		Default Green ▾	
DSS Key 4	None ▾			None ▾	AUTO ▾	DEFAULT ▾		Default Green ▾	

Picture 107 - DSS settings

Moreover, user also can add the user-defined title for the DSS Keys, which is configured as Memory Key / Line / URL / Multicast / Prefix.

More detailed information *refers to* [12.23 Function Key](#) and [6.3 Appendix III –LED Definition](#) .

10.5 Wi-Fi

The device supports wireless Internet access and requires the use of a USB wi-fi adapter specified by location; Therefore, the device needs to support U disk. Please refer to [4.2 hardware description](#) for the supported model.

When the device is in the default standby mode,

- Press soft-button **[Menu]** till you find the **[Basic]** item.
- Press **[WLAN]** to enter the setting interface.
- Select the wireless network and use the left and right keys to activate it. Enable the device to search the current wireless network automatically.
- Select to the available network, enter the user name and password to connect successfully.

Tip: if no wireless USB dongle is inserted, the prompt "wireless adapter has been removed" will appear. If a USB dongle is plugged in, the wireless network will be priority network even if the network cable is plugged in.



Picture 108 - WIFI settings

10.6 Headset

10.6.1 Wired Headset

- The device supports wired earphone with RJ9 interface, which can play incoming call sound and talk with earphone.
- After the phone is connected to the headset, the default DSS key of headset will be green light which indicating that the headset can be used normally.
- On the webpage **[Phone settings]** >> **[Features]**, you can set the headset answering function, and the ring tone for headset.

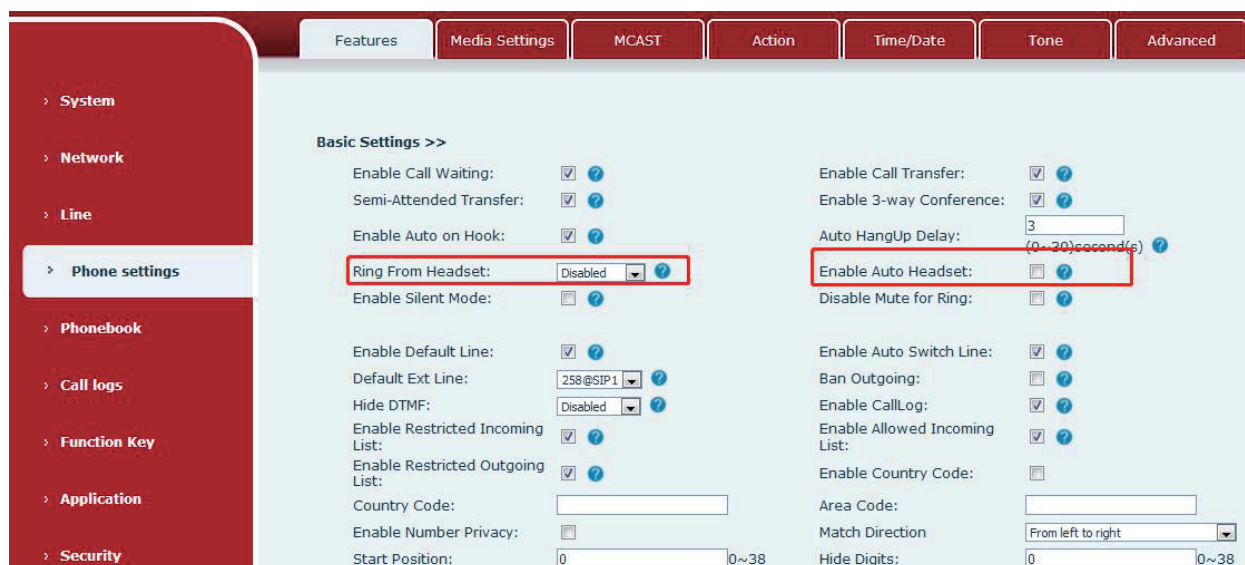

Picture 109 - Headset function settings

10.6.2 EHS Headset

Phone into [Menu] >> [Function] >> [Advanced], Select [EHS Headset] , can open EHS Headset (default closed EHS Headset).

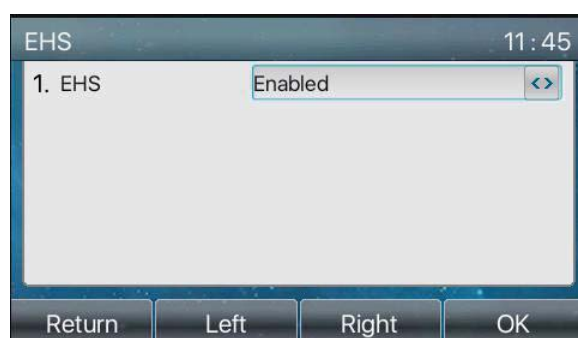

Picture 110 - EHS Headset setting

10.6.3 Bluetooth Headset

The device supports bluetooth application and can be compatible with bluetooth headset with CSR 4.0 chip. It needs to use USB bluetooth adapter specified by location. Therefore, the device needs to support U disk.

Please refer to [4.2 hardware description](#) for the supported model.

When the device is in the default standby mode,

- Press soft-button [Menu] till you find the [Basic] item.
- Press [Bluetooth] to enter the setup interface.
- Select Bluetooth, and use the left and right keys to enable Bluetooth. Select Paired Device. If no paired is displayed, press [Scan] key to search and select the scanned device to connect.



Picture 111 - Bluetooth Settings Screen

The use of Bluetooth headset can be divided into three types: call answering; Hang up; Bluetooth redial.

- call answering

When the Bluetooth headset is connected to the phone, the incoming call can be answered by pressing the Bluetooth answer button.

- Hang up

1) When talking with Bluetooth headset, you can hang up the phone by pressing the button on Bluetooth headset.

2) When there is an incoming call, double-click the answer button to reject the call.

3) When the caller is in the ringing state, press the answer button of the headset to cancel the call.

- Bluetooth redial

When the Bluetooth headset is connected, double-click the answer button to redial the number dialed last time.

NOTICE! some models do not support double - click redial function. Whether this function is supported or not, you can check the instruction of the headset, or connect the Bluetooth headset to the phone, and double-click the answer button to see whether it will redial.

10.7 Advanced

10.7.1 Line Configurations



Picture 112 - SIP address and account information

Save the adjustment by pressing [OK] when done.

Users who want to configure more options should use web management portal to modify or Advanced Settings in accounts on the individual line to configure those options.

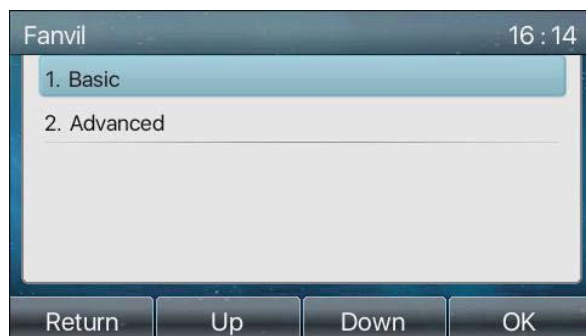

Picture 113 - Configure Advanced Line Options

10.7.2 Network Settings

10.7.2.1 Network Settings

■ IP Mode

There are 3 network protocol mode options, IPv4, IPv6 and IPv4 & IPv6.

User could select available mode via “<” or “>”. The selected IP mode will be activated after pressing [OK] button.



Picture 114 - Network mode Settings

■ IPv4

In IPv4 mode, there are 3 connection mode options: DHCP, PPPoE and Static IP.

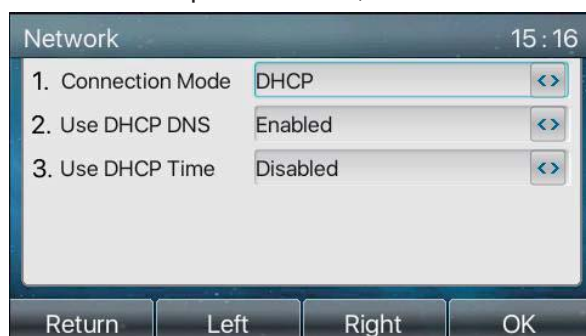

Picture 115 - DHCP network mode

When using DHCP mode, phone will get the IP address from DHCP server (router).

- Use DHCP DNS: It is enabled as default. “Enable” means phone will get DNS address from DHCP server and “disable” means not.
- Use DHCP time: It is disabled as default. “Enable” to manage the time of get DNS address from

DHCP server and “disable” means not.

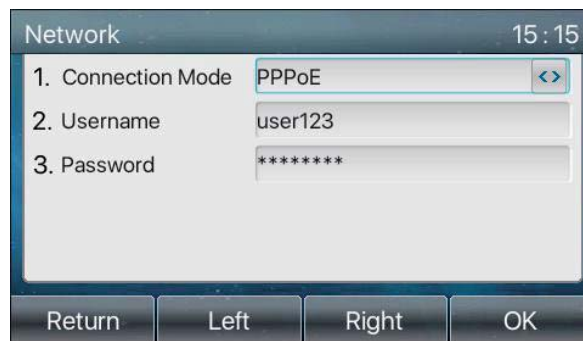

Picture 116 - PPPoE network mode

When using PPPoE, phone will get the IP address from PPPoE server.

- Username: PPPoE user name.
- Password: PPPoE password.

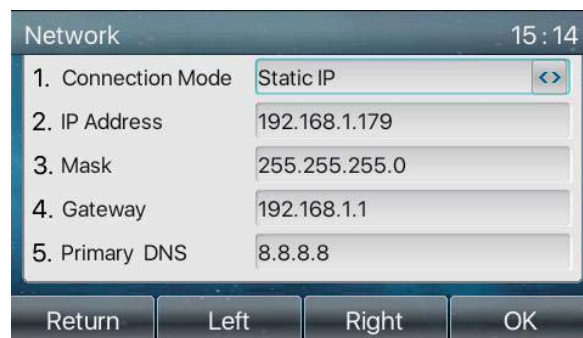

Picture 117 - Static IP network mode

When using Static IP mode, user must configure the IP address manually.

- IP Address: Phone IP address.
- Mask: sub mask of your LAN.
- Gateway: The gateway IP address. Phone could access the other network via it.
- Primary DNS: Primary DNS address. The default is 8.8.8.8, Google DNS server address.
- Secondary DNS: When primary DNS is not available, Secondary DNS will work.

■ **IPv6**

In IPv6, there are 2 connection mode options, DHCP and Static IP.

- DHCP configuration refers to IPv4 introduction in last page.
- Static IP configuration is almost same as IPv4's, except the IPv6 Prefix.
- IPv6 Prefix: IPv6 prefix, it is similar with mask of IPv4.

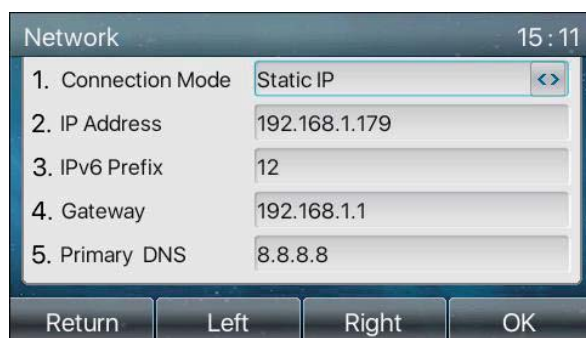

Picture 118 - IPv6 Static IP network mode

10.7.2.2 QoS & VLAN

■ LLDP

Link Layer Discovery Protocol. LLDP is a vendor independent link layer protocol used by network devices for advertising their identity, capabilities to neighbors on a LAN segment.

Phone could use LLDP to find the VLAN switch or other VLAN devices and use LLDP learn feature to apply the VLAN ID from VLAN switch to phone its self.

■ CDP

Cisco Discovery Protocol. CDP is a not-for-profit charity that runs the global disclosure system for investors, companies, cities, states and regions to manage their environmental impacts. According to the CDP, Cisco devices could share the OS version, IP address, hardware version and so on.

Table 19 - QoS & VLAN

Parameters	Description
LLDP setting	
Report	Enable LLDP
Interval	LLDP requests interval time
Learning	apply the learned VLAN ID to the phone configuration
QoS	
QoS Mode	configure SIP DSCP and audio DSCP
WAN VLAN	
WAN VLAN	WAN port VLAN configuration
LAN VLAN	
LAN VLAN	LAN port VLAN configuration
CDP	
CDP	CDP enable/disable , CDP interval time

Note: QoS & VLAN details refer to

<http://www.fanvil.com/Uploads/Temp/download/20180920/5ba383b56c3ef.pdf>

10.7.2.3 VPN

Virtual Private Network (VPN) is a technology to allow device to create a tunneling connection to a server and

becomes part of the server's network. The network transmission of the device may be routed through the VPN server.

For some users, especially enterprise users, a VPN connection might be required to be established before activate a line registration. The device supports two VPN modes, Layer 2 Transportation Protocol (L2TP) and OpenVPN.

The VPN connection must be configured and started (or stopped) from the device web portal.

■ L2TP

NOTICE! The device only supports non-encrypted basic authentication and non-encrypted data tunneling. For users who need data encryption, please use OpenVPN instead.

To establish a L2TP connection, users should log in to the device web portal, open webpage [**Network**] >> [**VPN**]. In VPN Mode, check the "Enable VPN" option and select "L2TP", then fill in the L2TP server address, Authentication Username, and Authentication Password in the L2TP section. Press "Apply" then the device will try to connect to the L2TP server.

When the VPN connection established, the VPN IP Address should be displayed in the VPN status. There may be the delay of the connection establishment. User may need to refresh the page to update the status. Once the VPN is configured, the device will try to connect with the VPN automatically when the device boots up every time until user disable it. Sometimes, if the VPN connection does not establish immediately, user may try to reboot the device and check if VPN connection established after reboot.

■ OpenVPN

To establish an OpenVPN connection, user should get the following authentication and configuration files from the OpenVPN hosting provider and name them as the following,

OpenVPN Configuration file:	client.ovpn
CA Root Certification:	ca.crt
Client Certification:	client.crt
Client Key:	client.key

User then upload these files to the device in the web page [**Network**] >> [**VPN**], select OpenVPN Files. Then user should check "Enable VPN" and select "OpenVPN" in VPN Mode and click "Apply" to enable OpenVPN connection.

Same as L2TP connection, the connection will be established every time when system rebooted until user disable it manually.

<http://www.fanvil.com/Uploads/Temp/download/20180920/5ba38303bfcf0.pdf>

10.7.2.4 Web Server Type

Configure the Web Server mode to be HTTP or HTTPS and will be activated after the reboot. Then user could use http/https protocol to access pone web page.

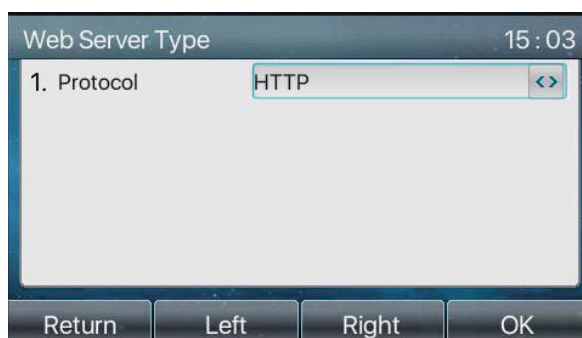

Picture 119 - The phone configures the web server type

10.7.3 Set The Secret Key

When the device is in the default standby mode,

- Select **[Menu]** >> **[Advanced setting]**, and enter it via **[Confirm]** or **[OK]** button.
- As default, the Advance setting password is 123.
- User will see the follow page after menu – Advanced setting – Security.



Picture 120 - Keypad lock password

Menu password is the permission for accessing the advanced setting.

- **[Current password]** is the password user configured before. If no configuration before, the default password is 123.
- **[New password]** is the new password user to use.
- After configuring the menu password, it will work immediately.
- Keyboard password is used to unlock the phone once it's locked.

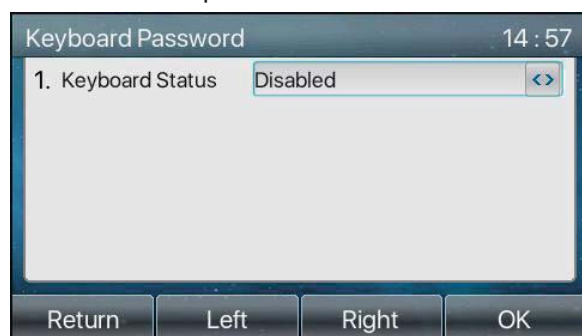

Picture 121 - Set keyboard lock password

User could only set to enable or disable the keyboard password in LCD screen.

- Enter [Keyboard password] setting by pressing [confirm] or [OK] button after password entered. If no menu password configuration before, it is 123 as default.
- If the menu password is correct, phone will go to keyboard password interface. As default, the keyboard password is disabled. When it is enabled, the keyboard will be locked after timeout.
- If user does not configure the keyboard lock time, (it is 0 as default). Long pressing “#” will lock the phone. There will be a lock icon in the top of LCD. Phone will reminder “Enter Password” after pressing any keys.

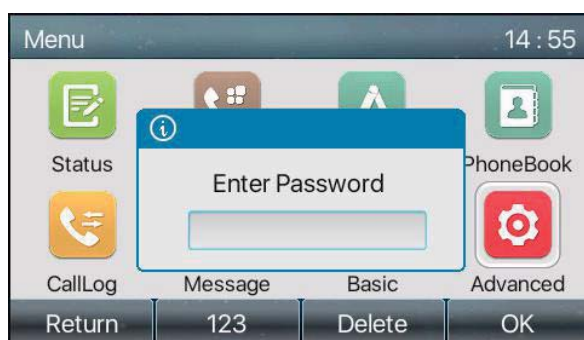

Picture 122 - Phone keypad lock password input interface

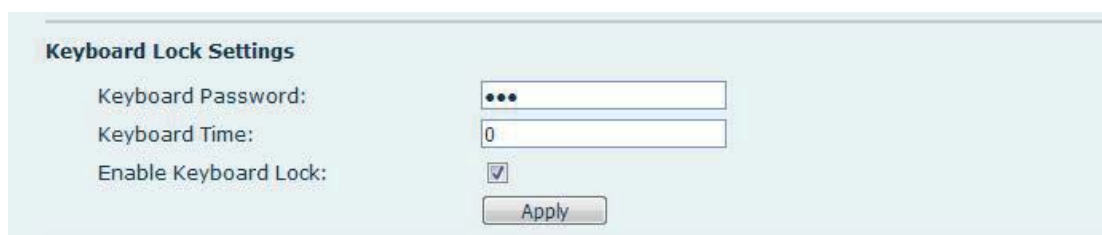

Picture 123 - Web keyboard lock password Settings

10.7.4 Maintenance

Phone Webpage: Login and go to [System] >> [Auto provision].

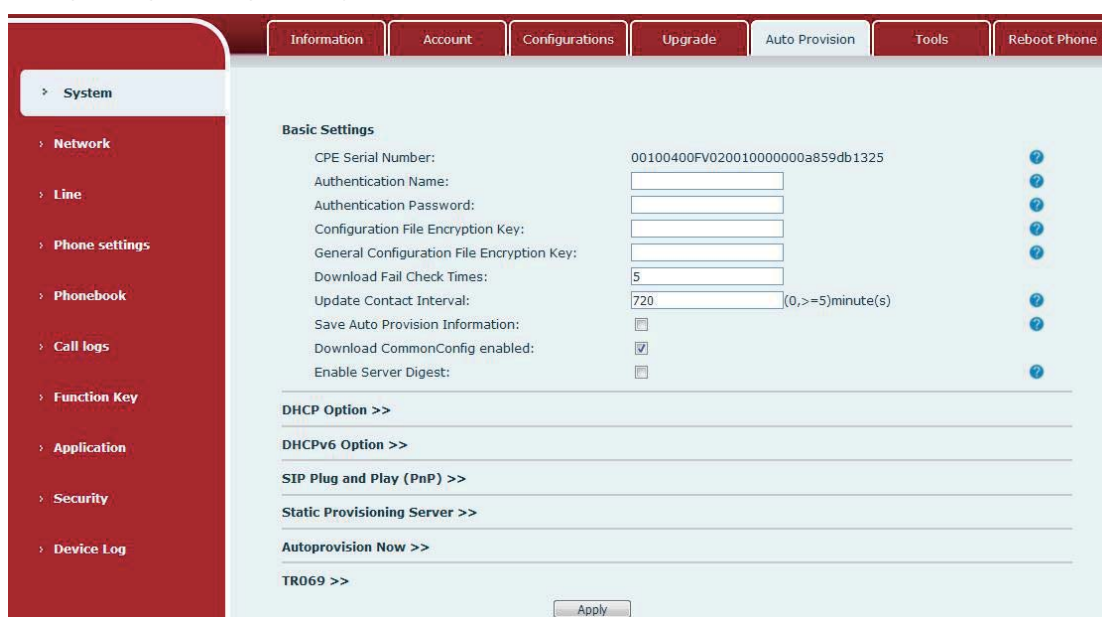

Picture 124 - Page auto provision Settings

LCD: [Menu] >> [Advanced setting] >> [Maintenance] >> [Auto Provision].



Picture 125 - Phone auto provision settings

Fanvil devices support SIP PnP, DHCP options, Static provision, TR069. If all of the 4 methods are enabled, the priority from high to low as below:

PNP>DHCP>TR069> Static Provisioning

Transferring protocol: FTP, TFTP, HTTP, HTTPS

Details refer to **Fanvil Auto Provision in**

<http://www.fanvil.com/Uploads/Temp/download/20180920/5ba3816f8d5f0.pdf>

Table 20 - Auto Provision

Parameters	Description
Basic settings	
CPE Serial Number	Display the device SN
Authentication Name	The user name of provision server
Authentication Password	The password of provision server
Configuration File Encryption Key	If the device configuration file is encrypted , user should add the encryption key here
General Configuration File Encryption Key	If the common configuration file is encrypted, user should add the encryption key here
Download Fail Check Times	If there download is failed, phone will retry with the configured times.
Update Contact Interval	Phone will update the phonebook with the configured interval time. If it is 0, the feature is disabled.
Save Auto Provision Information	Save the HTTP/HTTPS/FTP user name and password. If the provision URL is kept, the information will be kept.
Download Common Config enabled	Whether phone will download the common configuration file.
Enable Server Digest	When the feature is enable, if the configuration of server is changed, phone will download and update.
DHCP Option	
Option Value	Configre DHCP option, DHCP option supports DHCP custom option

	DHCP option 66 DHCP option 43, 3 methods to get the provision URL. The default is Option 66.
Custom Option Value	Custom Option value is allowed from 128 to 254. The option value must be same as server define.
Enable DHCP Option 120	Use Option120 to get the SIP server address from DHCP server.
SIP Plug and Play (PnP)	
Enable SIP PnP	Whether enable PnP or not. If PnP is enable, phone will send a SIP SUBSCRIBE message with broadcast method. Any server can support the feature will respond and send a Notify with URL to phone. Phone could get the configuration file with the URL.
Server Address	Broadcast address. As default, it is 224.0.0.0.
Server Port	PnP port
Transport Protocol	PnP protocol, TCP or UDP.
Update Interval	PnP message interval.
Static Provisioning Server	
Server Address	Provisioning server address. Support both IP address and domain address.
Configuration File Name	The configuration file name. If it is empty, phone will request the common file and device file which is named as its MAC address. The file name could be a common name, \$mac.cfg, \$input.cfg. The file format supports CFG/TXT/XML.
Protocol Type	Transferring protocol type , supports FTP、TFTP、HTTP and HTTPS
Update Interval	Configuration file update interval time. As default it is 1, means phone will check the update every 1 hour.
Update Mode	Provision Mode. 1. Disabled. 2. Update after reboot. 3. Update after interval.
TR069	
Enable TR069	Enable TR069 after selection
ACS Server Type	There are 2 options Serve type, common and CTC.
ACS Server URL	ACS server address
ACS User	ACS server username (up to is 59 character)
ACS Password	ACS server password (up to is 59 character)
Enable TR069 Warning Tone	If TR069 is enabled, there will be a prompt tone when connecting.
TLS Version	TLS version (TLS 1.0, TLS 1.1, TLS 1.2)
INFORM Sending Period	INFORM signal interval time. It ranges from 1s to 999s
STUN Server Address	Configure STUN server address

STUN Enable	To enable STUN server for TR069
-------------	---------------------------------

10.7.5 Firmware Upgrade

- Web page: Login phone web page, go to **[System]** >> **[Upgrade]**.

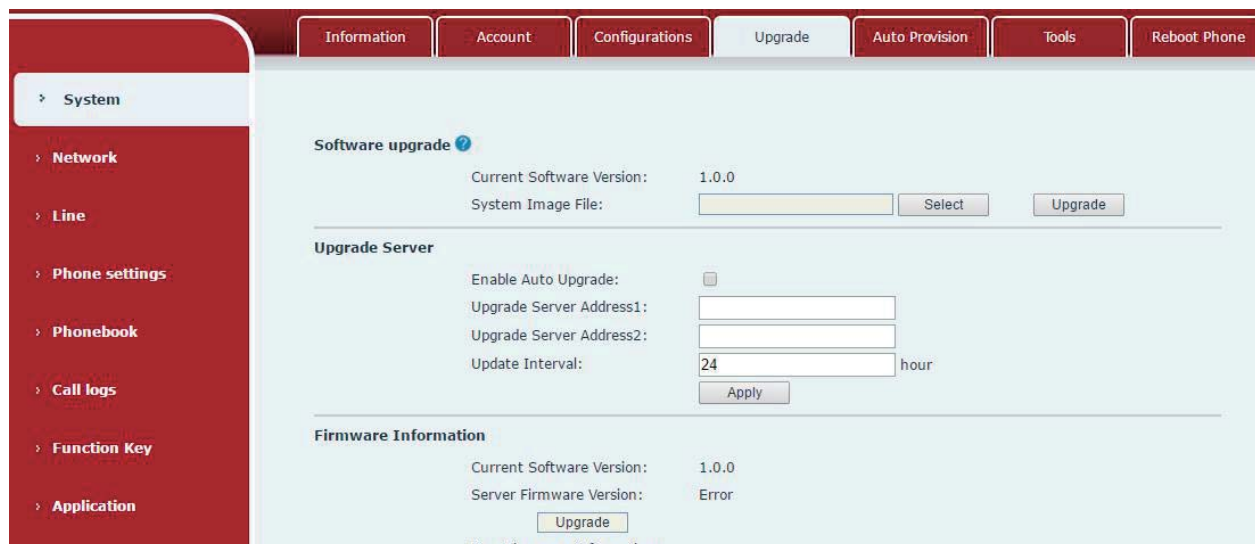

Picture 126 - Web page firmware upgrade

- LCD interface: go to **[Menu]** >> **[Advanced setting]** >> **[Firmware Upgrade]** .

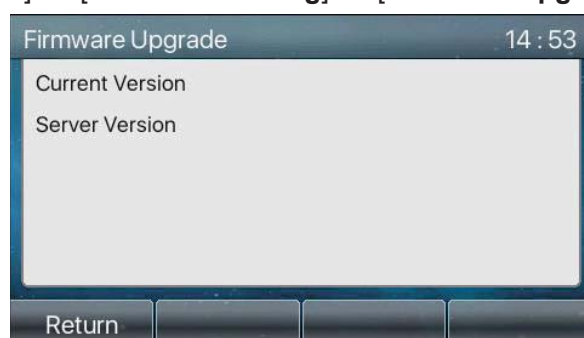

Picture 127 - Firmware upgrade information display

Table 21 - Firmware upgrade

Parameter	Description
Upgrade server	
Enable Auto Upgrade	Enable automatic upgrade, If there is a new version txt and new software firmware on the server, phone will show a prompt upgrade message after Update Interval.
Upgrade Server Address1	Set available upgrade server address.
Upgrade Server Address2	Set available upgrade server address.
Update Interval	Set Update Interval.
Firmware Information	

Current Software Version	It will show Current Software Version.
Server Firmware Version	It will show Server Firmware Version.
[Upgrade] button	If there is a new version txt and new software firmware on the server, the page will display version information and upgrade button will become available; Click [Upgrade] button to upgrade the new firmware.
New version description information	When there is a corresponding TXT file and version on the server side, the TXT and version information will be displayed under the new version description information.

- The file requested from the server is a TXT file called vendor_model_hw10.txt.Hw followed by the hardware version number, it will be written as hw10 if no difference on hardware. All Spaces in the filename are replaced by underline.
- The URL requested by the phone is HTTP:// server address/vendor_Model_hw10.txt: The new version and the requested file should be placed in the download directory of the HTTP server, as shown in the figure:

名称	修改日期	类型	大小
fanvil_x6_hww1_0.txt	2018/9/11 17:57	文本文档	1 KB
fanvil_x6_hww1_1.txt	2018/9/11 17:57	文本文档	1 KB
fanvil_x6_hww1_2.txt	2018/9/11 17:57	文本文档	1 KB
fanvil_x6_hww1_3.txt	2018/9/11 17:57	文本文档	1 KB
x6-6904-P0.12.12-1.6.3-2502T2018-0...	2018/8/21 19:52	WinRAR 压缩文...	35,847 KB

- TXT file format must be UTF-8
- vendor_model_hw10.TXT The file format is as follows:
Version=1.6.3 #Firmware
Firmware=xxx/xxx.z #URL, Relative paths are supported and absolute paths are possible, distinguished by the presence of protocol headers.
BuildTime=2018.09.11 20:00
Info=TXT|XML

Xxxxx
Xxxxx
Xxxxx
Xxxxx
- After the interval of update cycle arrives, if the server has available files and versions, the phone will prompt as shown below. Click [view] to check the version information and upgrade.



Picture 128 - Firmware upgrade

10.7.6 Factory Reset

The phone is in default standby mode.

- Press [**Menu**] to find [**Advanced Settings**], and press [**OK**].
- Press [**Advanced Settings**] to enter the password (default password is 123) to enter the interface.
- Press the [**Restore factory Settings**] button to select the file to be cleared.
- Press [**OK**] to clear after completion. When you select clear configuration file and clear all, the phone will restart automatically after clearing.

11 Web Configurations

11.1 Web Page Authentication

The user can log into the web page of the phone to manage the user's phone information and operate the phone. Users must provide the correct user name and password to log in.

11.2 System >> Information

User can get the system information of the device in this page including,

- Model
- Hardware Version
- Software Version
- Uptime

And summarization of network status,

- Network Mode
- MAC Address
- IP
- Subnet Mask
- Default Gateway

Besides, summarization of SIP account status,

- SIP User
- SIP account status (Registered / Unapplied / Trying / Timeout)

11.3 System >> Account

On this page the user can change the password for the login page.

Users with administrator rights can also add or delete users, manage users, and set permissions and passwords for new users.

11.4 System >> Configurations

On this page, users with administrator privileges can view, export, or import the phone configuration, or restore the phone to factory Settings.

■ Clear Configurations

Select the module in the configuration file to clear.

SIP: account configuration.

AUTOPROVISION: automatically upgrades the configuration

TR069:TR069 related configuration

MMI: MMI module, including authentication user information, web access protocol, etc.

DSS Key: DSS Key configuration

- **Clear Data Tables**

Select the local data table to be cleared, all selected by default.

- **Reset Phone**

The phone data will be cleared, including configuration and database tables.

11.5 System >> Upgrade

Upgrade the phone software version, customized ringtone, background, DSS Key icon, etc., can also be upgraded to delete the file. Ring tone support “.wav” format.

11.6 System >> Auto Provision

The Auto Provision settings help IT manager or service provider to easily deploy and manage the devices in mass volume. For the detail of Auto Provision, please refer to this link Auto Provision Description。

<http://www.fanvil.com/Uploads/Temp/download/20180920/5ba3816f8d5f0.pdf>

11.7 System >> Tools

Tools provided in this page help users to identify issues at trouble shooting. Please refer to [13 Trouble Shooting](#) for more detail.

11.8 System >> Reboot Phone

This page can restart the phone.

12 Network >> Basic

This page allows users to configure network connection types and parameters.

12.1 Network >> Service Port

This page provides settings for Web page login protocol, protocol port settings and RTP port.

Picture 129 - Service Port Settings

Table 22 - Service port

Parameter	Description
Web Server Type	Reboot to take effect after settings. Optionally, the web page login is HTTP/HTTPS.
Web Logon Timeout	Default as 15 minutes, the timeout will automatically exit the login page, need to login again.
Web auto login	After the timeout does not need to enter a user name password, will automatically login to the web page.
HTTP Port	The default is 80. If you want system security, you can set ports other than 80. Such as :8080, webpage login: HTTP://ip:8080
HTTPS Port	The default is 443, the same as the HTTP port.
RTP Port Range Start	The value range is 1025 to 65535. The value of RTP port starts from the initial value set. For each call, the value of voice and video port is added 2.
RTP Port Quantity	Number of calls.

12.2 Network >> VPN

Users can configure a VPN connection on this page. See [10.7.2.3 VPN](#) for more details.

12.3 Network >> Advanced

Advanced network Settings are typically configured by the IT administrator to improve the quality of the phone service. For configuration, query the [10.7 advanced](#) Settings.

12.4 Line >> SIP

Configure the Line service configuration on this page.

Table 23 - Line configuration on the web page

Parameters	Description
Register Settings	
Line Status	Display the current line status at page loading. To get the up to date line status, user has to refresh the page manually.
Activate	Whether the service of the line is activated
Username	Enter the username of the service account.
Authentication User	Enter the authentication user of the service account
Display Name	Enter the display name to be sent in a call request.
Authentication Password	Enter the authentication password of the service account
Realm	Enter the SIP domain if requested by the service provider
Server Name	Input server name.
SIP Server 1	
Server Address	Enter the IP or FQDN address of the SIP server
Server Port	Enter the SIP server port, default is 5060
Transport Protocol	Set up the SIP transport line using TCP or UDP or TLS.
Registration Expiration	Set SIP expiration date.
SIP Server 2	
Server Address	Enter the IP or FQDN address of the SIP server
Server Port	Enter the SIP server port, default is 5060
Transport Protocol	Set up the SIP transport line using TCP or UDP or TLS.
Registration Expiration	Set SIP expiration date.
SIP Proxy Server Address	Enter the IP or FQDN address of the SIP proxy server.
Proxy Server Port	Enter the SIP proxy server port, default is 5060.
Proxy User	Enter the SIP proxy user.
Proxy Password	Enter the SIP proxy password.
Backup Proxy Server Address	Enter the IP or FQDN address of the backup proxy server.
Backup Proxy Server Port	Enter the backup proxy server port, default is 5060.
Basic Settings	

Enable Auto Answering	Enable auto-answering, the incoming calls will be answered automatically after the delay time
Auto Answering Delay	Set the delay for incoming call before the system automatically answered it
Call Forward Unconditional	Enable unconditional call forward, all incoming calls will be forwarded to the number specified in the next field
Call Forward Number for Unconditional	Set the number of unconditional call forward
Call Forward on Busy	Enable call forward on busy, when the phone is busy, any incoming call will be forwarded to the number specified in the next field.
Call Forward Number for Busy	Set the number of call forward on busy .
Call Forward on No Answer	Enable call forward on no answer, when an incoming call is not answered within the configured delay time, the call will be forwarded to the number specified in the next field.
Call Forward Number for No Answer	Set the number of call forward on no answer.
Call Forward Delay for No Answer	Set the delay time of not answered call before being forwarded.
Transfer Timeout	Set the timeout of call transfer process.
Conference Type	Set the type of call conference, Local=set up call conference by the device itself, maximum supports two remote parties, Server=set up call conference by dialing to a conference room on the server
Server Conference Number	Set the conference room number when conference type is set to be Server
Subscribe For Voice Message	Enable the device to subscribe a voice message waiting notification, if enabled, the device will receive notification from the server if there is voice message waiting on the server
Voice Message Number	Set the number for retrieving voice message
Voice Message Subscribe Period	Set the interval of voice message notification subscription
Enable Hotline	Enabling hotline configuration, the device will dial to the specific number immediately at audio channel opened by off-hook handset or turn on hands-free speaker or headphone
Hotline Delay	Set the delay for hotline before the system automatically dialed it
Hotline Number	Set the hotline dialing number
Dial Without Registered	Set call out by proxy without registration
Enable Missed Call Log	If enabled, the phone will save missed calls into the call history record.

DTMF Type	Set the DTMF type to be used for the line
DTMF SIP INFO Mode	Set the SIP INFO mode to send '*' and '#' or '10' and '11'
Enable DND	Enable Do-not-disturb, any incoming call to this line will be rejected automatically
Subscribe For Voice Message	Enable the device to subscribe a voice message waiting notification, if enabled, the device will receive notification from the server if there is voice message waiting on the server
Use VPN	Set the line to use VPN restrict route
Use STUN	Set the line to use STUN for NAT traversal
Enable Failback	Whether to switch to the primary server when it is available.
Failback Interval	A Register message is used to periodically detect the time interval for the availability of the main Proxy.
Signal Failback	Multiple proxy cases, whether to allow the invite/register request to also execute failback.
Signal Retry Counts	The number of attempts that the SIP Request considers proxy unavailable under multiple proxy scenarios.
Codecs Settings	Set the priority and availability of the codecs by adding or remove them from the list.
Video Codecs	Select video code to preview video.
Advanced Settings	
Use Feature Code	When this setting is enabled, the features in this section will not be handled by the device itself but by the server instead. In order to control the enabling of the features, the device will send feature code to the server by dialing the number specified in each feature code field.
Enable DND	Set the feature code to dial to the server
Disable DND	Set the feature code to dial to the server
Enable Call Forward Unconditional	Set the feature code to dial to the server
Disable Call Forward Unconditional	Set the feature code to dial to the server
Enable Call Forward on Busy	Set the feature code to dial to the server
Disable Call Forward on Busy	Set the feature code to dial to the server
Enable Call Forward on No Answer	Set the feature code to dial to the server
Disable Call Forward on No Answer	Set the feature code to dial to the server

Enable Blocking Anonymous Call	Set the feature code to dial to the server
Disable Blocking Anonymous Call	Set the feature code to dial to the server
Call Waiting On Code	Set the feature code to dial to the server
Call Waiting Off Code	Set the feature code to dial to the server
Send Anonymous On Code	Set the feature code to dial to the server
Send Anonymous Off Code	Set the feature code to dial to the server
SIP Encryption	Enable SIP encryption such that SIP transmission will be encrypted
RTP Encryption	Enable RTP encryption such that RTP transmission will be encrypted
Enable Session Timer	Set the line to enable call ending by session timer refreshment. The call session will be ended if there is not new session timer event update received after the timeout period
Session Timeout	Set the session timer timeout period
Enable BLF List	Enable/Disable BLF List
BLF List Number	BLF List allows one BLF key to monitor the status of a group. Multiple BLF lists are supported.
Response Single Codec	If setting enabled, the device will use single codec in response to an incoming call request
BLF Server	The registered server will receive the subscription package from ordinary application of BLF phone. Please enter the BLF server, if the sever does not support subscription package, the registered server and subscription server will be separated.
Keep Alive Type	Set the line to use dummy UDP or SIP OPTION packet to keep NAT pinhole opened
Keep Alive Interval	Set the keep alive packet transmitting interval
Keep Authentication	Keep the authentication parameters from previous authentication
Blocking Anonymous Call	Reject any incoming call without presenting caller ID
User Agent	Set the user agent, the default is Model with Software Version.
Specific Server Type	Set the line to collaborate with specific server type
SIP Version	Set the SIP version
Anonymous Call Standard	Set the standard to be used for anonymous
Local Port	Set the local port
Ring Type	Set the ring tone type for the line
Enable user=phone	Sets user=phone in SIP messages.
Use Tel Call	Set use tel call

Auto TCP	Using TCP protocol to guarantee usability of transport for SIP messages above 1500 bytes
Enable Rport	Set the line to add rport in SIP headers
Enable PRACK	Set the line to support PRACK SIP message
DNS Mode	Select DNS mode, A, SRV, NAPTR
Enable Long Contact	Allow more parameters in contact field per RFC 3840
Enable Strict Proxy	Enables the use of strict routing. When the phone receives packets from the server, it will use the source IP address, not the address in via field.
Convert URI	Convert not digit and alphabet characters to %hh hex code
Use Quote in Display Name	Whether to add quote in display name, i.e. "Fanvil" vs Fanvil
Enable GRUU	Support Globally Routable User-Agent URI (GRUU)
Sync Clock Time	Time Sync with server
Enable Inactive Hold	With the post-call hold capture package enabled, you can see that in the INVITE package, SDP is inactive.
Caller ID Header	Set the Caller ID Header
Use 182 Response for Call waiting	Set the device to use 182 response code at call waiting response
Enable Feature Sync	Feature Sync with server
Enable SCA	Enable/Disable SCA (Shared Call Appearance)
CallPark Number	Set the CallPark number.
Server Expire	Set the timeout to use the server.
TLS Version	Choose TLS Version.
uaCSTA Number	Set uaCSTA Number.
Enable Click To Talk	With the use of special server, click to call out directly after enabling.
Flash mode	Chose Flash mode, normal or SIP info.
Flash Info Content-Type	Set the SIP info content type.
Flash Info Content-Body	Set the SIP info content body.
PickUp Number	Set the scramble number when the Pickup is enabled.
JoinCall Number	Set JoinCall Number.
Intercom Number	Set Intercom Number.
Unregister On Boot	Whether to enable logout function.
Enable MAC Header	When opening the registration, are IP package and user agent with MAC.
Enable Register MAC Header	When opening the registration, is user agent with MAC.
BLF Dialog Strict Match	Whether to enable accurate matching of BLF sessions.
PTime(ms)	Set whether to bring ptime field, default no.

SIP Global Settings	
Strict Branch	Set up to strictly match the Branch field.
Enable Group	Set open group.
Enable RFC4475	Set to enable RFC4475.
Enable Strict UA Match	Enable strict UA matching.
Registration Failure Retry Time	Set the registration failure retry time.
Local SIP Port	Modify the phone SIP port.

12.5 Line >> SIP Hotspot

Please refer to [9.9 SIP Hotspot](#).

12.6 Line >> Dial Plan

Picture 130 - Dial plan settings

Table 24 - Phone 7 dialing methods

Parameters	Description
Press # to invoke dialing	The user dials the other party's number and then adds the # number to dial out;
Dial Fixed Length	The number entered by the user is automatically dialed out when it reaches a fixed length
Timeout dial	The system dials automatically after timeout
Press # to Do Blind Transfer	The user enters the number to be transferred and then presses the "#" key to transfer the current call to a third party
Blind Transfer on Onhook	After the user enters the number, hang up the handle or turn off the hands-free function to transfer the current call to a third party.

Attended Transfer on Onhook	Hang up the handle or press the hands-free button to realize the function of attention-transfer, which can transfer the current call to a third party.
Attended Transfer on Conference Onhook	During a three-way call, hang up the handle and the remaining two parties remain on the call.
Enable E.164	Please refer to e. 164 standard specification

Add dialing rules:

Picture 131 - Custom setting of dial - up rules

Table 25 - Dial - up rule configuration table

Parameters	Description
Dial rule	There are two types of matching: Full Matching or Prefix Matching. In Full matching, the entire phone number is entered and then mapped per the Dial Peer rules. In prefix matching, only part of the number is entered followed by T. The mapping with then take place whenever these digits are dialed. Prefix mode supports a maximum of 30 digits.
Note: Two different special characters are used. <ul style="list-style-type: none"> ■ x -- Matches any single digit that is dialed. ■ [] -- Specifies a range of numbers to be matched. It may be a range, a list of ranges separated by commas, or a list of digits. 	
Destination	Set Destination address. This is for IP direct.
Port	Set the Signal port, and the default is 5060 for SIP.
Alias	Set the Alias. This is the text to be added, replaced or deleted. It is an optional item.
Note: There are four types of aliases.	

<ul style="list-style-type: none"> ■ all: xxx – xxx will replace the phone number. ■ add: xxx – xxx will be dialed before any phone number. ■ del –The characters will be deleted from the phone number. ■ rep: xxx – xxx will be substituted for the specified characters. 	
Suffix	Characters to be added at the end of the phone number. It is an optional item.
Length	Set the number of characters to be deleted. For example, if this is set to 3, the phone will delete the first 3 digits of the phone number. It is an optional item.

This feature allows the user to create rules to make dialing easier. There are several different options for dial rules. The examples below will show how this can be used.

Example 1: All Substitution -- Assume that it can make a direct IP call to IP address 172.168.2.208. Using this feature, 123 can be substituted for 172.168.2.208.

Index	Digit Map	Call	Match to Send	Line	Alias Type: Number(length)	Suffix	Media
1	"123"	Out	No	SIP DIALPEER(172.16.1.15:5560)			Default

Picture 132 - Dial rules table (1)

Example 2: Partial Substitution -- To dial a long distance call to Beijing requires dialing area code 010 before the local phone number. Using this feature 1 can be substituted for 010. For example, to call 62213123 would only require dialing 162213123 instead of 01062213123.

Index	Digit Map	Call	Match to Send	Line	Alias Type: Number(length)	Suffix	Media
1	"1T"	Out	No	Fanvil@SIP1	rep:010(1)		Default

Picture 133 - Dial rules table (2)

Example 3: Addition -- Two examples are shown. In the first case, it is assumed that 0 must be dialed before any 11 digit number beginning with 13. In the second case, it is assumed that 0 must be dialed before any 11 digit number beginning with 135, 136, 137, 138, or 139. Two different special characters are used.

x -- Matches any single digit that is dialed.

[] -- Specifies a range of numbers to be matched. It may be a range, a list of ranges separated by commas, or a list of digits.

12.7 Line >> Action Plan

1. When a IP phone calls a phone, the bound IP camera synchronously transmits video to the other phone (video is supported);This feature is only supported by X6U.
2. When SIP calls, multicast calls or intercom calls are made, the device converts calls that conform to the number rules into group calls.

Table 26 - IP camera

Parameter	Description
Number	Auxiliary phone number (support video)
Type	Support video display on call.
Direction	For call mode, incoming/outgoing call displays video
Line	Set up outgoing lines.
Username	Bind the user name of the IP camera.
Password	Bind IP camera password.
URL	Video streaming information;Mcast Address (mcast://IP:port)
User Agent	Set user agent information

12.8 Line >> Basic Settings

Set up the register global configuration.

Table 27 - Set the line global configuration on the web page

Parameters	Description
STUN Settings	
Server Address	Set the STUN server address
Server Port	Set the STUN server port, default is 3478
Binding Period	Set the STUN binding period which can be used to keep the NAT pinhole opened.
SIP Waiting Time	Set the timeout of STUN binding before sending SIP messages
The TLS authentication	
TLS Certification File	Upload or delete the TLS certification file used for encrypted SIP transmission.

12.9 Line >> RTCP-XR

RTCP-XR mode is based on RFC3611 (RTP Control Extended Report), which can measure and evaluate network packet loss, delay and voice quality by sending RTCP-XR packets.

Table 28 - VQ RTCP-XR Settings

Parameters	Description
VQ RTCP-XR Settings	
VQ RTCP-XR Session Report	VQ report on whether session mode is enabled or not.

VQ RTCP-XR Interval Report	Whether to turn on Interval mode for VQ report sending.
Period for Interval Report(5~99)	The time interval at which VQ reports are sent periodically.
Warning threshold for Moslq(15~40)	When the phone calculated the Moslq value x10 below the set threshold, a warning was issued.
Critical threshold for Moslq(15~40)	When the phone calculates the Moslq value x10 below the set threshold, the critical report is issued.
Warning Threshold for Delay(10~2000)	When the one-way delay of the phone is greater than the set threshold, warning is issued.
Critical Threshold for Delay(10~2000)	When the phone computes that the one-way delay is greater than the set threshold, the critical report is issued.
Display Report Options on web	Whether to display the VQ report data for the last call through the web page.

Note: the above functions are supported by X4U&X5U&X6U

12.10 Phone settings >> Features

Configuration phone features.

Table 29 - General function Settings

Parameters	Description
Basic Settings	
Enable Call Waiting	Enable this setting to allow user to take second incoming call during an established call. Default enabled.
Enable Call Transfer	Enable Call Transfer.
Semi-Attended Transfer	Enable Semi-Attended Transfer by selecting it
Enable 3-Way Conference	Enable 3-way conference by selecting it
Enable Auto Onhook	The phone will hang up and return to the idle automatically at hands-free mode
Auto Onhook Time	Specify Auto Onhook time, the phone will hang up and return to the idle automatically after Auto Hand down time at hands-free mode, and play dial tone Auto Onhook time at handset mode
Ring for Headset	Enable Ring for Handset by selecting it, the phone plays ring tone from handset.
Auto Headset	Enable this feature, headset plugged in the phone, user press 'answer' key or line key to answer a call with the headset automatically.
Enable Silent Mode	When enabled, the phone is muted, there is no ringing when calls, you can use the volume keys and mute key to unmute.
Disable Mute for Ring	When it is enabled, you can't mute the phone
Enable Default Line	If enabled, user can assign default SIP line for dialing out rather than

	SIP1.
Enable Auto Switch Line	Enable phone to select an available SIP line as default automatically
Default Ext Line	Select the default line to use for outgoing calls
Ban Outgoing	If you select Ban Outgoing to enable it, and you cannot dial out any number.
Hide DTMF	Configure the hide DTMF mode.
Enable CallLog	Select whether to save the call log.
Enable Restricted Incoming List	Whether to enable restricted call list.
Enable Allowed Incoming List	Whether to enable the allowed call list.
Enable Restricted Outgoing List	Whether to enable the restricted allocation list.
Enable Country Code	Whether the country code is enabled.
Country Code	Fill in the country code.
Area Code	Fill in the area code.
Enable Number Privacy	Whether to enable number privacy.
Match Direction	Matching direction, there are two kinds of rules from right to left and from left to right.
Start Position	Open number privacy after the start of the hidden location.
Hide Digits	Turn on number privacy to hide the number of digits.
Allow IP Call	If enabled, user can dial out with IP address
P2P IP Prefix	Prefix a point-to-point IP call.
Caller Name Priority	Change caller ID display priority.
Emergency Call Number	Set Emergency Call Number
Search path	Select the search path.
LDAP Search	Select from with one LDAP for search
Emergency Call Number	Configure the Emergency Call Number. Despite the keyboard is locked, you can dial the emergency call number
Restrict Active URI Source IP	Set the device to accept Active URI command from specific IP address. More details please refer to this link http://www.fanvil.com/Uploads/Temp/download/20180920/5ba3641fe81a5.pdf .
Push XML Server	Configure the Push XML Server, when phone receives request, it will determine whether to display corresponding content on the phone which sent by the specified server or not.
Enable Pre-Dial	Disable this feature, user enter number will open audio channel automatically.

	Enable the feature, user enter the number without opening audio channel.
Enable Multi Line	If enabled, up to 10 simultaneous calls can exist on the phone, and if disabled, up to 2 simultaneous calls can exist on the phone.
Line Display Format	Custom line format: SIPn/SIPn: xxx/xxx@SIPn
Contact As White List Type	NONE/BOTH/DND White List/FWD White List
Block XML When Call	Disable XML push on call.
SIP notify	When enabled, the phone displays the information when it receives the relevant notify content.
Tone Settings	
Enable Holding Tone	When turned on, a tone plays when the call is held
Enable Call Waiting Tone	When turned on, a tone plays when call waiting
Play Dialing DTMF Tone	Play DTMF tone on the device when user pressed a phone digits at dialing, default enabled.
Play Talking DTMF Tone	Play DTMF tone on the device when user pressed a phone digits during taking, default enabled.
DND Settings	
DND Option	Select to take effect on the line or on the phone or close.
Enable DND Timer	Enable DND Timer, If enabled, the DND is automatically turned on from the start time to the off time.
DND Start Time	Set DND Start Time
DND End Time	Set DND End Time
Intercom Settings	
Enable Intercom	When intercom is enabled, the device will accept the incoming call request with a SIP header of Alert-Info instruction to automatically answer the call after specific delay.
Enable Intercom Mute	Enable mute mode during the intercom call
Enable Intercom Tone	If the incoming call is intercom call, the phone plays the intercom tone
Enable Intercom Barge	Enable Intercom Barge by selecting it, the phone auto answers the intercom call during a call. If the current call is intercom call, the phone will reject the second intercom call
Response Code Settings	
DND Response Code	Set the SIP response code on call rejection on DND
Busy Response Code	Set the SIP response code on line busy
Reject Response Code	Set the SIP response code on call rejection
Password Dial Settings	
Enable Password Dial	Enable Password Dial by selecting it, When number entered is beginning with the password prefix, the following N numbers after the password

	prefix will be hidden as *, N stand for the value which you enter in the Password Length field. For example: you set the password prefix is 3, enter the Password Length is 2, then you enter the number 34567, it will display 3**67 on the phone.
Encryption Number Length	Configure the Encryption Number length
Password Dial Prefix	Configure the prefix of the password call number
Power LED	
Common	Standby power lamp state, off when off, open is always bright red. Off by default.
SMS/MWI	The status of power lamp when there is unread short message/voice message, including off/on/slow flash/quick flash, default slow flash.
Missed	The state of the power lamp when there is a missed call, including off/on/slow flash/quick flash, the default slow flash.
Talk/Dial	In the talk/dial state, the power lamp state, off is off, on is always red bright, the default is off.
Ringling	Power lamp status when there is an incoming call, including off/on/slow flash/quick flash, default flash.
Mute	Power lamp status in mute mode, including off/on/slow flash/quick flash, off by default.
Hold/Held	The power lamp state, including off/on/slow flash/quick flash, is turned off by default when left/retained.
Notification Popups	
Display Missed Call Popup	No incoming call popup prompt after opening, no popup prompt when closing, open by default.
Display MWI Popup	Voice message popup prompt is not answered after opening, and it is opened by default if there is no popup prompt when closing.
Display Device Connect Popup	There is a popup prompt when the WIFI adapter is connected. There is no popup prompt when the WIFI adapter is closed. It is on by default.
Display SMS Popup	There is popup prompt for unread messages after opening, and there is no popup prompt when closing. It is opened by default.
Display Other Popup	When the handle is not hung back after opening, registration fails, IP acquisition fails, Tr069 connection fails and other abnormalities, there will be popup prompt when it is opened; otherwise, there will be no prompt when it is closed, and it will be opened by default.

12.11 Phone settings >> Media Settings

Change voice Settings.

Table 30 - Voice settings

Parameters	Description
Codecs Settings	Select enable or disable voice encoding: G.711A/U,G.722,G.729, G.726-16,G726-24,G726-32,G.726-40, ILBC, Opus
Audio Settings	
Handset Volume	Set the Handset volume, the value must be 1~9
Default Ring Type	Configure default ringtones. If no special ringtone is set for the phone number, the default ringtone will be used.
Speakerphone Volume	Set the hands-free volume to 1-9.
Headset Ring Volume	Set the volume of the earphone ringtone to 1~9.
Headset Volume	Set the volume of the headset to 1~9.
Speakerphone Ring Volume	Set the volume of hands-free ringtone to 1~9.
G.723.1 Bit Rate	5.3kb/s or 6.3kb/s is available.
DTMF Payload Type	Enter the DTMF payload type, the value must be 96~127.
AMR Payload Type	Set AMR load type, range 96~127.
Headset Mic Gain	Set the earphone's radio volume gain to fit different models of earphones.
Opus payload type	Set Opus load type, range 96~127.
OPUS Sample Rate	Set Opus sampling rate, including opus-nb (8KHz) and opus-wb (16KHz).
ILBC Payload Type	Set the ILBC Payload Type, the value must be 96~127.
ILBC Payload Length	Set the ILBC Payload Length
Enable MWI Tone	When there is a new voice message message, the phone will start a special dial tone.
Enable VAD	Whether voice activity detection is enabled.
Onhook Time	Configure a minimum response time, which defaults to 200ms
EHS Type	EHS headset is available after enabling.
RTP Control Protocol(RTCP) Settings	
CNAME user	Set CNAME user
CNAME host	Set CNAME host
RTP Settings	
RTP keep alive	Hold the call and send the packet after 30s
Alert Info Ring Settings	
Value	Set the value to specify the ring type.
Ring Type	Type1-Type9

12.12 Phone settings >> MCAST

This feature allows user to make some kind of broadcast call to people who are in multicast group. User can configure a multicast DSS Key on the phone, which allows user to send a Real Time Transport Protocol (RTP) stream to the pre-configured multicast address without involving SIP signaling. You can also configure the phone to receive an RTP stream from pre-configured multicast listening address without involving SIP signaling. You can specify up to 10 multicast listening addresses.

Table 31 - Multicast parameters

Parameters	Description
Normal Call Priority	Define the priority of the active call, 1 is the highest priority, 10 is the lowest.
Enable Page Priority	The voice call in progress shall take precedence over all incoming paging calls.
Name	Listened multicast server name
Host: port	Listened multicast server's multicast IP address and port.

12.13 Phone settings >> Action

Action URL

Note! Action urls are used for IPPBX systems to submit phone events. Please refer to Fanvil Action URL for details.

<http://www.fanvil.com/Uploads/Temp/download/20180920/5ba3641fe81a5.pdf>

12.14 Phone settings >> Time/Date

The user can configure the time Settings of the phone on this page.

Table 32 - Time&Date settings

Parameters	Description
Network Time Server Settings	
Time Synchronized via SNTP	Enable time-sync through SNTP protocol
Time Synchronized via DHCP	Enable time-sync through DHCP protocol
Primary Time Server	Set primary time server address
Secondary Time Server	Set secondary time server address, when primary server is not reachable, the device will try to connect to secondary time server to get time synchronization.
Time Zone	Select the time zone
Resync Period	Time of re-synchronization with time server
12-Hour Clock	Set the time display in 12-hour mode

Date Format	Select the time/date display format
Daylight Saving Time Settings	
Local	Choose your local, phone will set daylight saving time automatically based on the local
DST Set Type	Choose DST Set Type, if Manual, you need to set the start time and end time.
Fixed Type	Daylight saving time rules are based on specific dates or relative rule dates for conversion. Display in read-only mode in automatic mode.
Offset	The offset minutes when DST started
Month Start	The DST start month
Week Start	The DST start week
Weekday Start	The DST start weekday
Hour Start	The DST start hour
Minute Start	The DST start minute
Month End	The DST end month
Week End	The DST end week
Weekday End	The DST end weekday
Hour End	The DST end hour
Minute End	The DST end minute
Manual Time Settings	You can set your time manually

12.15 Phone settings >> Tone

This page allows users to configure a phone prompt.

You can either select the country area or customize the area. If the area is selected, it will bring out the following information directly. If you choose to customize the area, you can modify the button tone, call back tone and other information.

Tone Settings	
Select Your Tone:	United States
Dial Tone:	350+440/0
Ring Back Tone:	440+480/2000,0/4000
Busy Tone:	480+620/500,0/500
Congestion Tone:	
Call waiting Tone:	440/300,0/10000,440/300,0/10000,0/0
Holding Tone:	
Error Tone:	
Stutter Tone:	
Information Tone:	
Dial Recall Tone:	350+440/100,0/100,350+440/100,0/100,350+440/100,0/100,350+440/0
Message Tone:	
Howler Tone:	
Number Unobtainable Tone:	400/500,0/6000
Warning Tone:	1400/500,0/0
Record Tone:	440/500,0/5000
Auto Answer Tone:	

Apply

Picture 134 - Tone settings on the web

12.16 Phone settings >> Advanced

User can configure the advanced configuration settings in this page.

- Screen Configuration.
 - Enable Energy Saving
 - Backlight Time
- LCD Menu Password Settings.

The password is 123 by default.

- Keyboard Lock Settings.
- Configure Greeting Words

The greeting message will display on the top left corner of the LCD when the device is idle, which is limited to 16 characters. The default chars are 'VOIP PHONE'.

12.17 Phonebook >> Contact

User can add, delete, or edit contacts in the phonebook in this page. User can browse the phonebook and sorting it by name, phones, or filter them out by group.

To add a new contact, user should enter contact's information and press "Add" button to add it.

To edit a contact, click on the checkbox in front of the contact, the contact information will be copied to the contact edit boxes, press "Modify" button after finished editing.

To delete one or multiple contacts, check on the checkbox in front of the contacts wished to be deleted and click the "Delete" button, or click the "Clear" button with selecting any contacts to clear the phonebook.

User can also add multiple contacts into a group by selecting the group in the dropdown options in front of "Add to Group" button at the bottom of the contact list, selecting contacts with checkbox and click "Add to Group" to add selected contacts into the group.

Similarly, user can select multiple users and add them into blacklist by click “Add to Blacklist” button.

12.18 Phonebook >> Cloud phonebook

Cloud Phonebook

User can configure up to 8 cloud phonebooks. Each cloud phonebook must be configured with an URL where an XML phonebook is stored. The URL may be based on HTTP/HTTPS or FTP protocol with or without authentication. If authentication is required, user must configure the username and password.

To configure a cloud phonebook, the following information should be entered,

- Phonebook name (must)
- Phonebook URL (must)
- Access username (optional)
- Access password (optional)

LDAP Settings

The cloud phonebook allows user to retrieve contact list from a LDAP Server through LDAP protocols.

User must configure the LDAP Server information and Search Base to be able to use it on the device. If the LDAP server requests an authentication, user should also provide username and password.

To configure a LDAP phonebook, the following information should be entered,

- Display Title (must)
- LDAP Server Address (must)
- LDAP Server Port (must)
- Search Base (must)
- Access username (optional)
- Access password (optional)

Note! Refer to the LDAP technical documentation before creating the LDAP phonebook and phonebook server.

<http://www.fanvil.com/Uploads/Temp/download/20180920/5ba382eb399eb.pdf>

Web page preview

Phone page supports preview of Internet phone directory and contacts

- After setting up the XML Voip directory or LDAP,
- Select [**Phone book**] >> [**Cloud phone book**] >> [**Cloud phone book**] to select the type.
- Click the set XML/LDAP to download the contact for browsing.

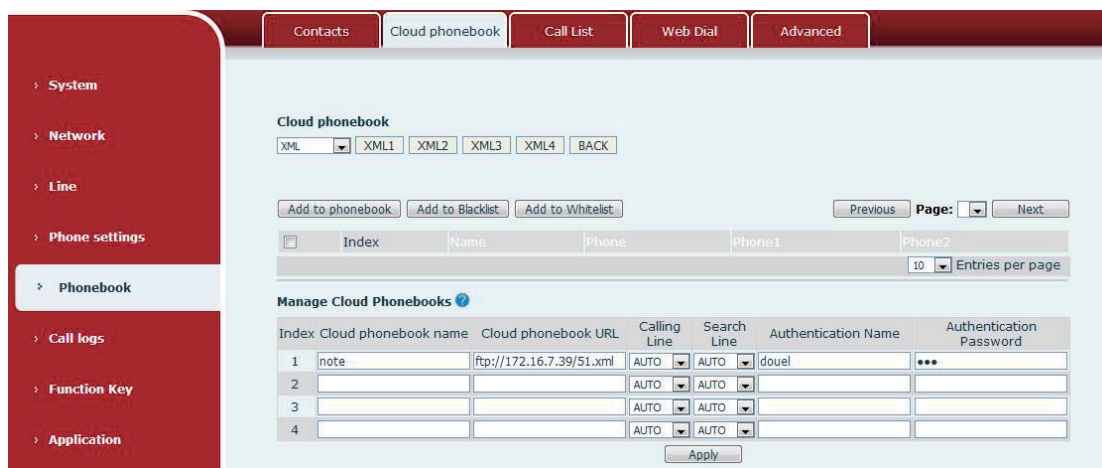

Picture 135 - Web cloud phone book Settings

12.19 Phonebook >> Call List

- Restricted Incoming Calls:

It is similar like a blacklist. Add the number to the blacklist, and the user will no longer receive calls from the stored number until the user removes it from the list.

Users can add specific Numbers to the blacklist or add specific prefixes to the blacklist to block calls with all Numbers with this prefix.

- Allowed Incoming Calls:

When DND is enabled, the incoming call number can still be called.

- Restricted Outgoing Calls:

Adds a number that restricts outgoing calls and cannot be called until the number is removed from the table.

12.20 Phonebook >> Web Dial

Use web pages for call, reply, and hang up operations.

12.21 Phonebook >> Advanced

Users can export the local phone book in XML, CSV, and VCF format and save it on the local computer.

Users can also import contacts into the phone book in XML, CSV, and VCF formats.

Attention! If the user imports the same phone book repeatedly, the same contact will be ignored. If the name is the same but the number is different, the contact is created again.

Users can delete groups or add new groups on this page. Deleting a contact group does not delete contacts in that group.

12.22 Call Log

The user can browse the complete call record in this page. The call record can be sorted by time. Call number, contact name or line, and the call record can be screened by call record type (incoming call, outgoing call,

missed call, forward call).

The user can also save the number in the call record to his/her phone book or add it to the blacklist/whitelist.

Users can also dial the web page by clicking on the number in the call log.

Users can also download call records conditionally and save them locally.

12.23 Function Key >> Function Key

One-key transfer Settings: establish new call, blind transfer, attention-transfer, one-key three-party, Play DTMF.

The device provides 2 user-defined shortcuts that users can configure on a web page.

Table 33 - Function Key configuration

Parameters	Description
Memory Key	<p>BLF (New Call/BXFE /AXFER): It is used to prompt user the state of the subscribe extension, and it can also pick up the subscribed number, which help user monitor the state of subscribe extension (idle, ringing, a call). There are 3 types for one-touch BLF transfer method.</p> <p>p.s. User should enter the pick-up number for specific BLF key to fulfill the pick-up operation.</p> <p>Presence: Compared to BLF, the Presence is also able to view whether the user is online.</p> <p>Note: You cannot subscribe the same number for BLF and Presence at the same time</p> <p>Speed Dial: You can call the number directly which you set. This feature is convenient for you to dial the number which you frequently dialed.</p> <p>Intercom: This feature allows the operator or the secretary to connect the phone quickly; it is widely used in office environments.</p>
Line	It can be configured as a Line Key. User is able to make a call by pressing Line Key.
Key Event	User can select a key event as a shortcut to trigger. For example: MWI / DND / Release / Headset / Hold / etc.
DTMF	It allows user to dial or edit dial number easily.
URL	Open the specific URL directly.
Multicast	Configure the multicast address and audio codec. User presses the key to initiate the multicast.
Action URL	The user can use a specific URL to make basic calls to the phone.
XML browser	Users can set the DSS Key for specific URL download and other operations.

12.24 Function Key >> Side Key

Side Key is a Key on both sides of the screen that functions as a shortcut Key. The default configuration is

line Key, which can be customized in the webpage. For Side Key function and Settings, please refer to [12.23 Function Key Settings](#).

12.25 Function Key >> Softkey

The User Settings mode and display style, display page.

Table 34 - Softkey configuration

Parameter	Description
Softkey Mode	
Softkey mode	Disabled and More, Default is Disabled
Softkey Style	
Softkey display style	Softkey Exit on Left or Right
Screen	
Call Dialer	Redial/2aB/Delete/Exit/Call Back/Dial/Join/MWI/Local Contacts/Pickup/Call Log/Missed/Clear/In/Dialed/Pause/ Next line/Prev line/Headset/Audio/Video/Remote XML/DSS Key
Conference	Hold/Split/End/Release/Mute/DSS Key/Headset
Desktop	Call Log/Menu/Local Contacts/DND/Prev Account/Next Account/Blacklist/Call Back/Call Forward/Locked/Memo/Missed/MWI/Dialed/Reboot/Redial/Remote XML/SMS/Headset/Status/DSS Key/In
Divert Dialed	Redial/2aB/Delete/Exit/Forward/Local Contacts/Call Log /Clear/Missed/Dialed/Headset/Video/Audio/Remote XML /DSS Key
Ending	Redial/End/Headset/Release/DSS Key
Predictive Dialer	Dial/2aB/Delete/Exit/Call Back/Local Contacts/Redial /Pickup/MWI/Join/Call Log/Release/Missed/Pause/Dialed/Headset/Video/Audio/Remote XML/DSS Key/In/Next line /Prev line
Ringling	Answer/Forward/Reject/Mute/Release/Headset/Video/Audio/DSS key
Talking	Hold/Transfer/Conference/End/Mute/Release/New Call/Local Contacts/Listen/Call Log/Next call/Prev call/Private/Headset/Video/Audio/DSS Key
Transfer Alerting	End/Transfer/Headset/Release/DSS Key
Transfer Dialer	Redial/Delete/Exit/2aB/Dial/Local Contacts/Transfer/Call Log/Clear/Missed/Dialed/Pause/Headset/Video/Audio/Remote XML/DSS Key
Trying	End/Release/Headset/DSS Key

Waiting	Hold/Transfer/Conference/End/Answer/Forward/Mute/Next call/New call/Prev call/Reject/Release/Headset/Listen/Video/Audio/DSS Key
---------	---

12.26 Function Key >> Advanced

One key transfer: for example, set the memory key 4370. Press the memory key when talking with 4374 to decide whether to call 4370 or transfer 4374 to 4370.

Select memory key function: for example, the phone set the memory key value to 4370. When 4370 calls, press this key to hold the call or hang up.

■ Global Key Settings

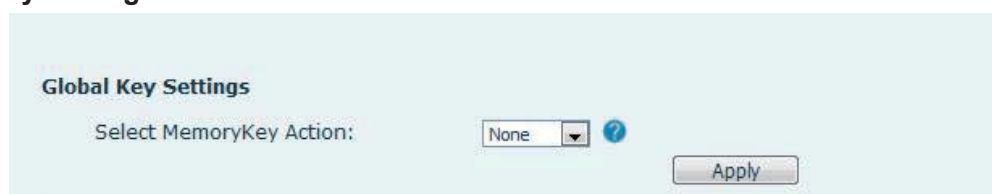

Picture 136 - Global Key Settings

■ Programmable key Settings

Please refer to the [Table 25 Softkey configuration](#)

12.27 Application >> Manage Recording

See [9.3 Record](#) for details of recording.

12.28 Security >> Web Filter

The user can set up a configuration management phone that allows only machines with a certain network segment IP access.

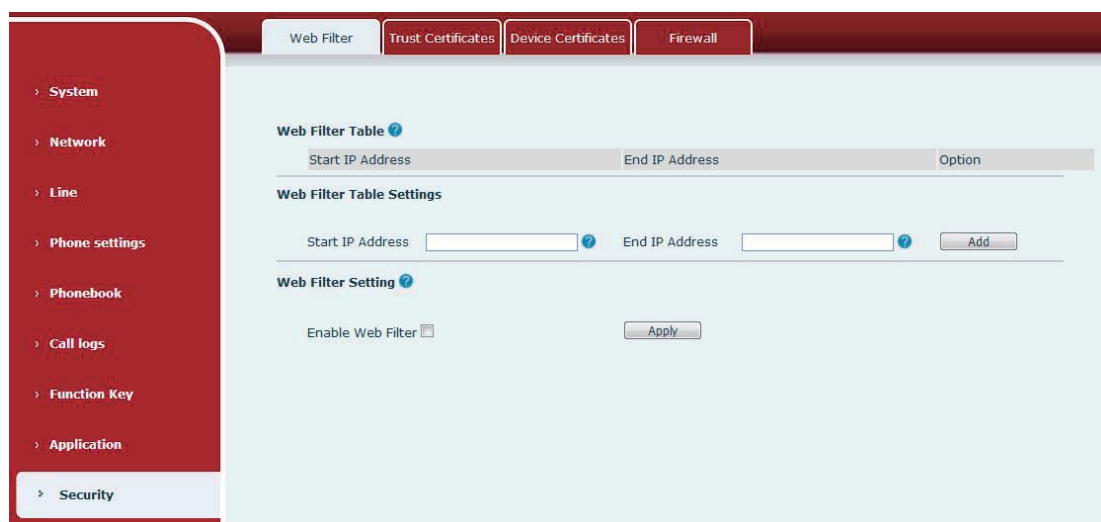

Picture 137 - Web Filter settings



Picture 138 - Web Filter Table

Adding and removing IP segments are accessible. Configure the starting IP address within the start IP, end the IP address within the end IP, and click **[Add]** to submit to take effect. A large network segment can be set, or it can be divided into several network segments to add. If the user wants to delete, select the initial IP of the network segment to be deleted from the drop-down menu, and then click **[Delete]** to take effect.

Enable web page filtering: configure enable/disable web page access filtering; Click the "apply" button to take effect.

Note: if the device you are accessing is in the same network segment as the phone, please do not configure the filter segment of the web page to be outside your own network segment, otherwise you will not be able to log in the web page.

12.29 Security >> Trust Certificates

Set whether to open license certificate and general name validation, select certificate module.

You can upload and delete uploaded certificates.

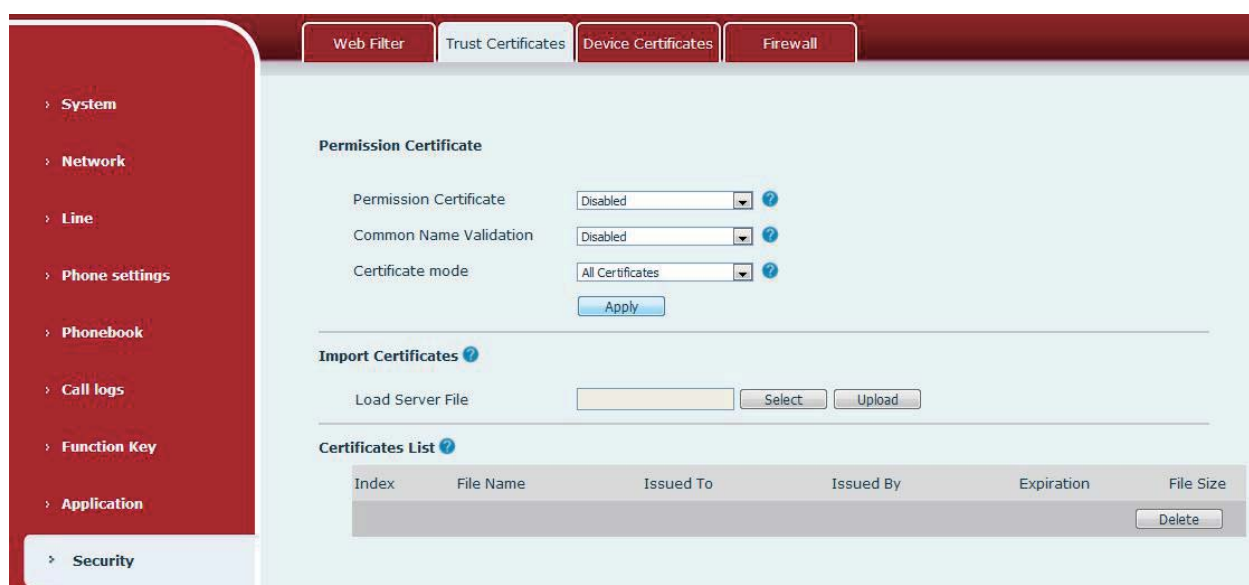

Picture 139 - Certificate of settings

12.30 Security >> Device Certificates

Select the device certificate as the default and custom certificate.

You can upload and delete uploaded certificates.



Picture 140 - Device certificate setting

12.31 Security >> Firewall

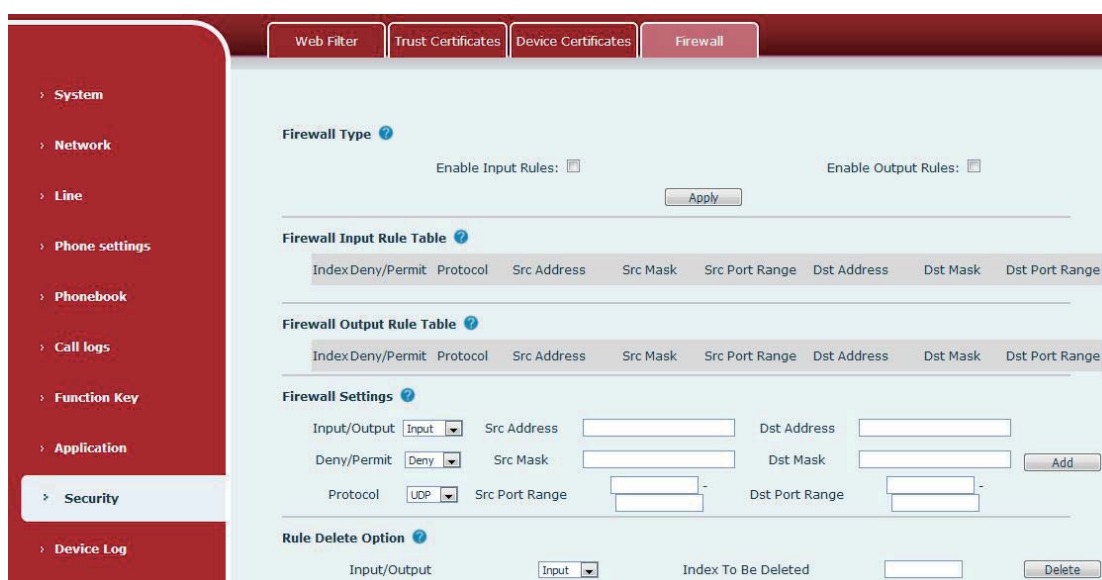

Picture 141 - Network firewall Settings

The user can set whether to enable the input through this page, output firewall and set the firewall input and output rules. Using these Settings can prevent some malicious network access, or restrict internal users access to some resources of the external network, which can improve security.

Firewall rule set is a simple firewall module. This feature supports two types of rules: input rules and output rules. Each rule is assigned an ordinal number, allowing up to 10 for each rule.

Considering the complexity of firewall Settings, the following is an example to illustrate:

Table 35 - Network Firewall

Parameter	Description
Enable Input Rules	Indicates that the input rule application is enabled.
Enable Output Rules	Indicates that the output rule application is enabled.

Input/Output	To select whether the currently added rule is an input or output rule.
Deny/Permit	To select whether the current rule configuration is disabled or allowed;
Protocol	There are four types of filtering protocols: TCP UDP ICMP IP.
Src Port Range	Filter port range
Src Address	Source address can be host address, network address, or all addresses 0.0.0.0; It can also be a network address similar to *.*.*.0, such as: 192.168.1.0.
Dst Address	The destination address can be either the specific IP address or the full address 0.0.0.0; It can also be a network address similar to *.*.*.0, such as: 192.168.1.0.
Src Mask	Is the source address mask. When configured as 255.255.255.255, it means that the host is specific. When set as 255.255.255.0, it means that a network segment is filtered.
Dst Mask	Is the destination address mask. When configured as 255.255.255.255, it means the specific host. When set as 255.255.255.0, it means that a network segment is filtered.

After setting, click **[Add]** and a new item will be added in the firewall input rule, as shown in the figure below:

Index	Deny/Permit	Protocol	Src Address	Src Mask	Src Port Range	Dst Address	Dst Mask	Dst Port Range
1	deny	udp	192.168.1.0	192.168.1.154	0-9	255.255.255.0	255.255.255.0	0-9

Picture 142 - Firewall Input rule table

Then select and click the button **[Apply]**.

In this way, when the device is running: ping 192.168.1.118, the packet cannot be sent to 192.168.1.118 because the output rule is forbidden. However, the other IP of the ping 192.168.1.0 network segment can still receive the response packet from the destination host normally.

Rule Delete Option

Input/Output: Index To Be Deleted:

Picture 143 - Delete firewall rules

Select the list you want to delete and click **[Delete]** to delete the selected list.

12.32 Device Log >> Device Log

You can grab the device log, and when you encounter an abnormal problem, you can send the log to the technician to locate the problem. See [13.6 Get log information.](#)

13 Trouble Shooting

When the phone is not in normal use, the user can try the following methods to restore normal operation of the phone or collect relevant information and send a problem report to Fanvil technical support mailbox.

13.1 Get Device System Information

Users can get information by pressing the **[Menu]** >> **[Status]** option in the phone. The following information will be provided:

The network information

Equipment information (model, software and hardware version), etc.

13.2 Reboot Device

Users can reboot the device from soft-menu, **[Menu]** >> **[Basic]** >> **[Reboot System]**, and confirm the action by **[OK]**. Or, simply remove the power supply and restore it again.

13.3 Reset Device to Factory Default

Resetting Device to Factory Default will erase all the user's configuration, preference, database and profiles on the device and restore the device back to the state as factory default.

To perform a factory default reset, user should press **[Menu]** >> **[Advanced]**, and then input the password to enter the interface. Then choose **[Factory Reset]** and press **[Enter]**, and confirm the action by **[OK]**. The device will be rebooted into a clean factory default state.

13.4 Screenshot

If there is a problem with the phone, the screenshot can help the technician locate the function and identify the problem. In order to obtain screen shots, log in the phone webpage **[System]** >> **[Tools]**, and you can capture the pictures of the main screen and the secondary screen (you can capture them in the interface with problems).

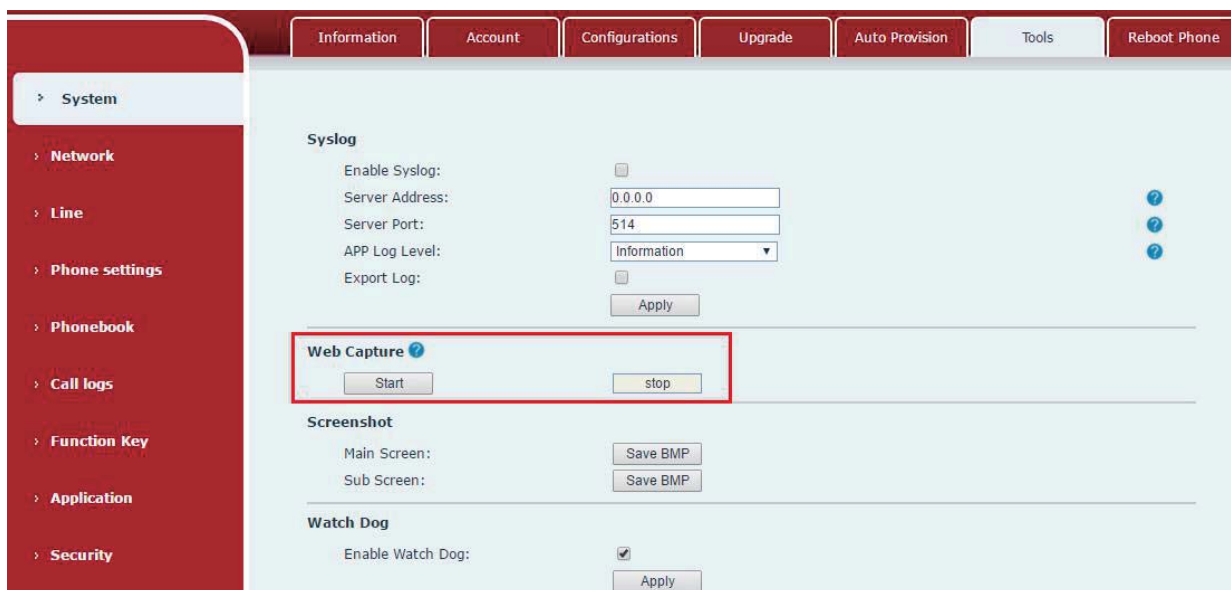

Picture 144 - Screenshot

13.5 Network Packets Capture

Sometimes it is helpful to dump the network packets of the device for issue identification. To get the packets dump of the device, user needs to log in the device web portal, open page [**System**] >> [**Tools**] and click [**Start**] in “Network Packets Capture” section. A pop-up message will be prompt to ask user to save the capture file. User then should perform the relevant operations such as activating/deactivating line or making phone calls and click [**Stop**] button in the web page when operation finished. The network packets of the device during the period have been dumped to the saved file.

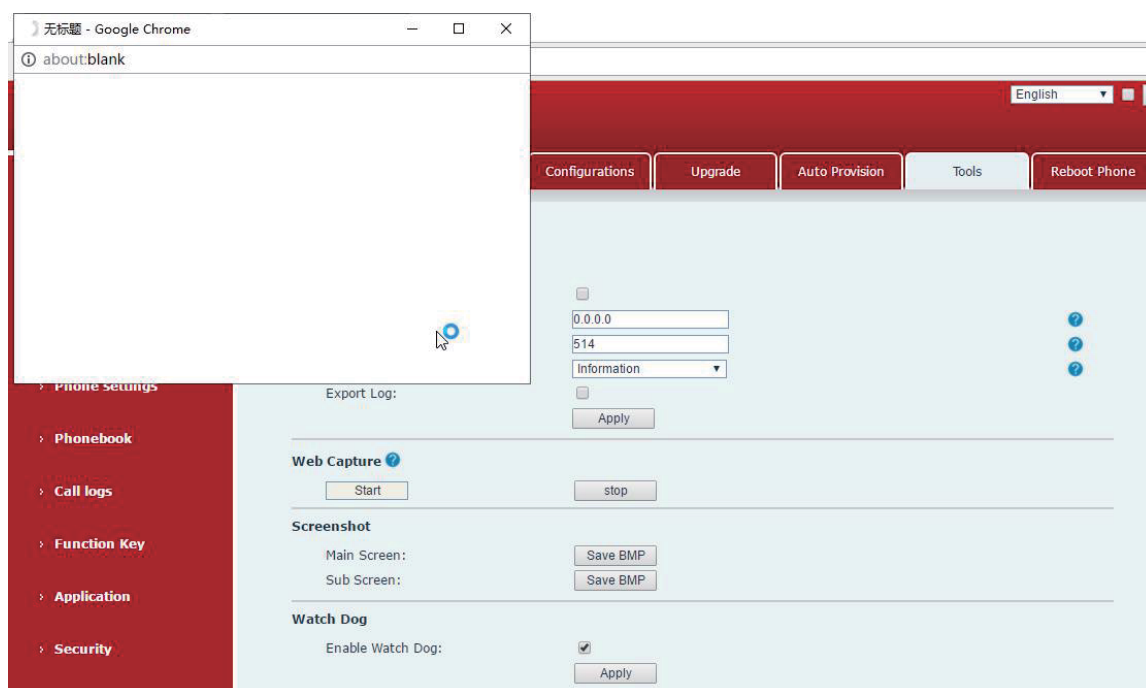

Picture 145 - Web capture





User may examine the packets with a packet analyzer or send it to Fanvil support mailbox.

13.6 Get Log Information

Log information is helpful when encountering an exception problem. In order to get the log information of the phone, the user can log in the phone web page, open the page [Device log], click the [Start] button, follow the steps of the problem until the problem appears, and then click the [End] button, [Save] to local analysis or send the log to the technician to locate the problem.

13.7 Common Trouble Cases

Table 36 - Trouble Cases

Trouble Case	Solution
Device could not boot up	<ol style="list-style-type: none"> 1. The device is powered by external power supply via power adapter or PoE switch. Please use standard power adapter provided by manufacturer or PoE switch met with the specification requirements and check if device is well connected to power source. 2. If you saw "POST MODE" on the device screen, the device system image has been damaged. Please contact location technical support to help you restore the phone system.
Device could not register to a service provider	<ol style="list-style-type: none"> 1. Please check if device is well connected to the network. The network Ethernet cable should be connected to the  [Network] port NOT the  [PC] port. If the cable is not well connected to the network icon  [WAN disconnected] will be flashing in the middle of the screen. 2. Please check if the device has an IP address. Check the system information, if the IP displays "Negotiating...", the device does not have an IP address. Please check if the network configurations is correct. 3. If network connection is fine, please check again your line configurations. If all configurations are correct, please kindly contact your service provider to get support, or follow the instructions in "13.5 Network Packet Capture" to get the network packet capture of registration process and send it to manufacturer support to analyze the issue.
No Audio or Poor Audio in Handset	<ol style="list-style-type: none"> 1. Please check if Handset is connected to the correct Handset  port NOT Headphone  port. 2. The network bandwidth and delay may be not suitable for audio call at the moment.

<p>Poor Audio or Low Volume in Headphone</p>	<ol style="list-style-type: none"> 1. There are two Headphone wire sequence in the market. Please use the Headphone provided by manufacturer, or consult manufacturer the wire sequence if you wish to use a third-party headphone. 2. The network bandwidth and delay may be not suitable for audio call at the moment.
<p>Audio is chopping at far-end in Hands-free speaker mode</p>	<p>This is usually due to loud volume feedback from speaker to microphone. Please lower down the speaker volume a little bit, the chopping will be gone.</p>